

fresh area solutions guide



siffron.

www.siffron.com | 800.422.2547



new

ModoShelf™



new

NEXT™ 2.0



new

4eBins™



new

GoMix™ Pick & Mix Display

Fresh Area Merchandising

Maximize impact with minimal use of space

Judging by the placement of enticing fresh displays at the entrance of nearly every grocery store, retailers are clearly aware that the fresh area is one of the most important sections of a store's layout. But, what makes this area so appealing to customers?

While location at the store entrance seems to be the most important factor, presentation follows a close second. Here are six factors to keep in mind when setting or resetting your fresh area:

- ◆ Keep displays looking full
- ◆ Maintain a flexible layout
- ◆ Merchandise vertically
- ◆ Refrigerate appropriately
- ◆ Use ample lighting
- ◆ Don't forget signage

This guide includes a wide variety of products to help you maximize impact with minimal use of space.



ModoShelf™	4
Fresh-Fit® Racks	12
Fresh-Fit® Merchandisers	14
Power Zone® Kwik-Set™ Self-facing System	18
Power Zone® Pre-Set™ Self-facing System	24
NEXT® 2.0.	26
4eBin™ Gravity Bin	33
Scoop Bins	37
GoMix™ Pick & Mix Display.	39
Cross Merchandisers.	40
Sign Holders	42
Bins	44
Mobile Merchandisers	45
Wicker Basket Displays	46
Baskets	48
Crates & Barrels	49
Fruit Cutters.	50
Scales	51
Scales & Bag Holder.	52
Floral Carts	53
Display Tree, Cubes & Crates.	54
Display Accessories/ Supplies	55
Cutters.	56
Containers.	57
Watering Systems	59
Displayware - Metal	60
Displayware - Designer Melamine	62
Displayware - Melamine Bowls	63
Displayware - Melamine Platters	66
Displayware - Melamine Trays	68
Displayware - Baskets	71
Pedestals	73
Risers	76
Wood Display Fixtures	81
Merchandisers	82
Sign Holders	84
Hot Food Merchandisers	87
Cold Food Merchandisers.	91
Food Service Accessories.	93
Mega Bar System.	95
Mega Bar Channel Hangers.	97
Case Inserts and Shelving.	99
Case Dividers and Accessories.	100
Sampling	105
Shopping Baskets	106
Accessories	107
Safety/Janitorial.	108
Storage and Transportation	111





ModoSHELF™

the best place to display your merchandise
in any way you want to display it

A grocery store's produce area is critically important to a supermarket's success due to its high level of traffic and increased revenue. Retailers know that differentiating themselves in this area is of utmost importance.

Many things can detract from this area as well. These distractions include poor display of merchandise, dirty or disorganized appearance, and the labor costs associated with managing and cleaning this retail space section.



Why ModoShelf™ is different

ModoShelf™ is a revolutionary shelving system that provides a wealth of benefits that addresses many of the challenges facing retail today. These needs address the concerns of functionality, cleanliness, and reduced labor.

With a modular, lightweight design, ModoShelf offers many design options to create beautiful product displays while optimizing merchandising space.

Its lightweight design means it can be set up easily by one person. The tile construction allows for easy disassembly to quickly and efficiently maintain cleaning protocols in the store's fresh area.

Combine all of this with its NSF certification, ModoShelf is one of the most reliable, versatile, and safe products on the market today.

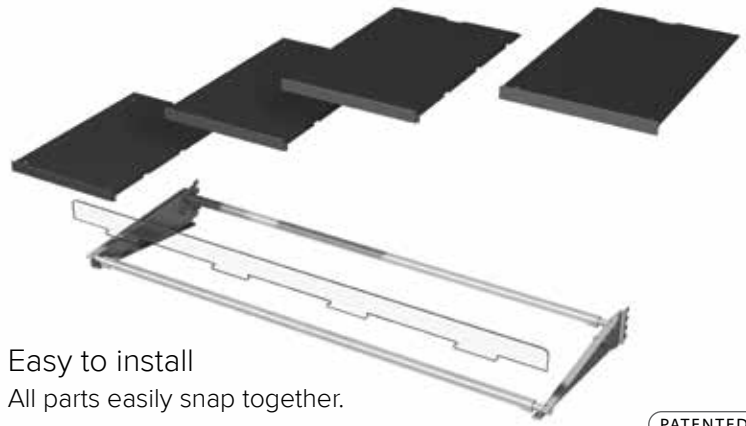

Easy to install
All parts easily snap together.
No tools required.

PATENTED

Dishwasher safe
Use Pot, Pan and Utensil Washer or 3-compartment sink wash and sanitizing process.



Pot, Pan and Utensil Washer

Benefits



Easy-to-clean - Removable antimicrobial ABS tiles are 100% dishwasher safe



Stainless steel rust proof frame is long lasting and guarantees food safety

DESIGN IT YOUR WAY

Modular design provides plenty of options

Imagine building an attractive and organized product presentation with angled shelving that promotes first-in, first-out rotation in mere minutes.

ModoShelf™ is a flexible and expandable grid system that's available in four different widths (12", 24", 36" and 48"). You can setup as little or as much display area as you need using our versatile design system. You can also adjust the angle of the shelves to four set positions: 0°, 10°, 20°, and 30°. ModoShelf's tiles are installed with a simple snap – no tools required.



Contact siffron for a custom quote.



ModoShelf™ Features

1. Shelf Construction



Lightweight tiles combined with a tube frame allows for one-person installation - no tools required

2. Grid Uprights



Insert as many uprights as needed for your shelf configuration - no tools required

3. Grid Mounting Bar



The grid mounting bars, top and bottom, inserts into standard uprights and securely hold Grid Uprights

4. Tile Installation



Tiles securely press-fit onto frame cross bars - no fasteners required. A four-foot shelf can hold up to 250 pounds

5. Tile Construction



Tiles are molded out of durable, recyclable ABS plastic that is optimized for cooler airflow



6. Accessories



Variety of plastic and wire fences and dividers available, utilize front slots and shelf perforations

7. Shelf Frame Assembly



Frame ships knock-down to save freight. Snap cross bars onto side brackets for secure fit

8. Adjustable Shelf Angles



Adjustable angles with four different shelf positions: 0°, 10°, 20°, and 30°

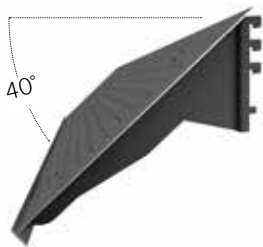

ModoShelf Slant shelves have a fixed, 40 degree angle and fit into standard cooler uprights

ModoShelf™ Slant Produce System

Reduce shrink significantly and keep produce looking fresh!

The angled shelves of ModoShelf Slant promote first-in, first-out stock rotation, which ensures produce always looks fresh – resulting in sales lift. ModoShelf Slant is typically set-up as a 3-tiered display consisting of 14” deep shelves on top, 20” deep shelves in the center, and 26” deep shelves on the bottom. All shelf brackets are permanently fixed at a 40-degree pitched angle.

ModoShelf Slant is designed to look like an organized “wall of produce,” making the case look full while carrying relatively low inventories to reduce shrink. There is no need for inventory blockers, dummies, or other extra components, as the steeply pitched angle of the shelves creates a physical limit to how much product employees can place on the showroom floor.



Asparagus / Herb Tray



Variety Bin



Gravity-Feed Root Bin

Item No.	Style	Dimensions	Pack
9924312095	Shelf	14” D x 48” L	1
9924312096	Shelf	20” D x 48” L	1
9924312097	Shelf	26” D x 48” L	1
9924010021	Acrylic Front Fence (20” & 26” D shelves)	5” H x 48” W	1
9924010022	Acrylic Front Fence (14” D shelves)	4.5” H x 48” W	1
9922811623	Asparagus / Herb Tray	14” D x 23” W	1
9923110053	Variety Bin	14” D x 24” W	1
9923110054	Variety Bin	20” D x 24” W	1
9923110055	Variety Bin	26” D x 24” W	1
9800007804	Well Variety Bin with Handles	26” D x 24” W	1
9924319816	Wire Divider	3” H x 14” D	1
9924319817	Wire Divider	4” H x 20” D	1
9924319818	Wire Divider	4” H x 26” D	1
9923210513	Gravity-Feed Root Bin	20” D x 24” W x 8.5” H	1

Modoshelf Wall

- Perfect for the “Wet Wall of Produce”, ModoShelf accessories allow you to customize the way you merchandise various product shapes and sizes with a minimum amount of product on the showroom floor.
- Boost sales and reduce shrink by forcing a higher rate of rotation, keeping your produce section looking fresh. Construct stunning, lavish displays without the need for large inventory.
- Unlike other “wall” systems which block cold air from the rear and allow it to drop down behind the racks; building the displays on shelves helps facilitate air-flow from the rear of the case like a natural air baffle. Large holes in the inventory control panel allow air to pass through easily and over the produce to the front air curtain of the refrigerator.
- Also, all blocker panels, dividers and shelf deck tiles remove quickly and easily for cleaning; then pop right back into place without needing to dismantle and rebuild entire Plan-O-Grams. No need to mess with large, cumbersome floor-to-ceiling racking!



Item No.	Description	Dimensions
9924312060	Blocker	-
9924312066	Divider	-

Additional colors can be made to order (minimum quantities apply).

ModoShelf™ Pods

ModoShelf™ Pods are a creative way to enhance the visual appeal of bulk produce that maximizes sales and profits. Rounded Pod shapes allow you to organize and separate individual categories and help visually distinguish specialty products, while also limiting the amount of product on the showroom floor – reducing shrink!



9924312074

9924312141

9924312140



Item No.	Description	Dimensions
9924312074	ModoShelf MiniPods	48"W x 12"D (Each full round is 12"W)
9924312140	ModoShelf Pod Display; 2 Full 16"D Pods	48"W x 16"D (Each full round is 24"W)
9924312141	ModoShelf Pod Display; 1 Full + 2 Halves; 16"D	48"W x 16"D (Each full round is 24"W)
9924319852	ModoShelf Pod Front Fence, Full (Center); Clear Acrylic	24"W x 2"H
9924319853	ModoShelf Pod Front Fence, Full; Clear Acrylic	12"W x 2"H
9924311970	ModoShelf Pod Front Fence (Center), Full; SS Wire	24"W x 2"H
9924311971	ModoShelf Pod Front Fence (Left/Right), Half; SS Wire	12"W x 2"H

Additional colors can be made to order (minimum quantities apply).

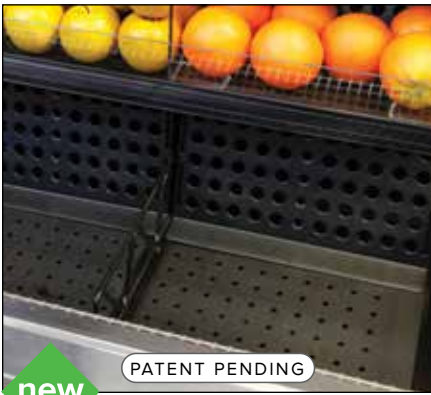

Well Merchandiser

The Modos Well Merchandiser is a truly innovative merchandising rack that is designed to install into the bottom (well) of refrigerated display cases, replacing the need for existing wire racking. This food-safe deck prevents smaller products and loose debris from falling between the wires of conventional racking. The Modos Well Rack eliminates the need for unsanitary case liner, while still utilizing a surface that reduces bruising.

- Cut the tedious cleaning process down dramatically and replace rust-prone wire racks.
- NSF Certified; easily-removable top deck constructed out of ABS plastic, which is dishwasher-safe and can be quickly cleaned and sanitized.
- Remove the deck for easy access to the “plenum” for deep-case cleaning and maintenance – no need to completely dismantle the Plan-O-Grams sections at a time.
- Add accessories for merchandising flexibility; ModosShelf Dividers and Blocker Panels snap onto the deck to create customizable, virtual bins in the bottom of the display case. Black wire (comes pre-assembled) or clear PETG front product stops (sits separately in front of rack, on top of mounting pins) are also optional features.
- Extends from 24” to 37” front-to-back to fit into various-depth cases.
- Sold in packs of 2 racks per case.

Item No.	Description	Dimensions	Pack
9925510004	Modo Well Flat Rack with mounting pins	24”W x 24”-37”L	2
9925510034	Modo Well Flat Rack with 6”H Wire Fence	24”W x 24”-37”L with 6”H Fence	2
9924017389	Clear PETG Product Stop	24”W x 6”H	1

Additional colors can be made to order (minimum quantities apply).

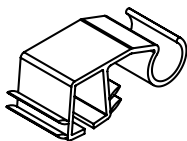

9924312061

Allura™ LED Lighting for ModosShelf™

- All components completely waterproof for use in misted environments
- All components either UL recognized or certified
- LED Light Bars available for 48”, 36” and 24” wide shelves
- Case Adapter Cords available for Hussmann®, Tyler® and Hillphoenix® cases
- Retrofit existing units
- Kit will include the LED Light Bars, Bar Holders, Power Supply, Harness Tree, Link Cables and the appropriate Case Adapter Cord
- Remove plastic decking tiles without the need to touch the LED Light Bars or unplugging wires.
- No tools are required
- 5 year warranty

Item No.	Ref No.	Dimensions	Finish	Pack
Standard				
UL16253422	RALL-LED-LWP22	22” L	White	10
UL16253434	RALL-LED-LWP34	34” L	White	10
UL16253446	RALL-LED-LWP46	46” L	White	10
High Output				
UL19221422-HO		22” L	White	1
UL19221434-HO		34” L	White	1
UL19221446-HO		46” L	White	1
Accessories				
9924312061			Clear	

NEXT® 2.0

- NEXT® 2.0 Pull-Out Tray and Bar Tray hooks directly onto mounting bars or utilize the NEXT 2.0 Shelf Trays with the front shelf-mount rail to affix directly onto ModoShelf itself.
- Compatible trays available in 13", 15", 17" and 19" depths
- For a clean in-line look, NEXT® 2.0 Tray depth should be 1" more than ModoShelf™ depth (eg. use 15" D tray with 14" D shelf)
- Pull-Out Tray extends 2/3 of the total tray length
- Pull-Out Tray makes it easy to load product into cooler sections
- Divider sides are expandable, to hold products between 4.6" to 10.5" wide
- Available with or without baffles
- A locking paddle makes loading and re-loading product a snap; paddle automatically releases when tray is closed
- Patented
- NSF Certified



NEXT® 2.0 Bar Tray

Roller Track™ Gravity Feed Shelf

- Gravity-feed design uses integrated rollers to self-face product
- NSF Certified
- Products remain visible and easily accessible
- Easy to install, stock, and reset to minimize labor
- Ideal for beverages, dairy, cleaning products, and convenience items
- Can be used in front- and rear-loading coolers
- Durable, long-lasting solution reduces waste and carbon footprint

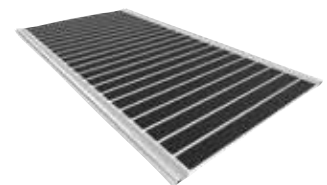

Power Zone® Kwik-Set™ Standard Kit

- Fastens directly to ModoShelf with molded-in clips; no external fasteners necessary.
- Includes Kwik-Connect™ Front Fence, Left End Divider, Center Push Dividers, Center Push Right End Divider, Center Pusher Tracks
- Product Stop is 1.75" H



* May be covered under one or more system patents.

Create a tiered produce display with Fresh-Fit® RPC Bin Direct Hook-In Shelves and Bins



RPC Display Bin



Fresh-Fit® RPC Bins

- Keep fruit and vegetables fresh and ensure the best temperature control by utilizing reusable packaging container (RPC) bins.
- RPC bins have walls that fold down for efficient storage when not in use, and are stackable once the walls are snapped quickly into the raised position; protecting the product inside from damage.
- A sustainable product, RPC bins are reusable over many years and are constructed from a recyclable polypropylene material.
- The ventilated design maximizes product freshness and quality and is ideal for point-of-sale displays.
- The ergonomic handles allow for efficient handling and reduce labor by simply replacing empty bins in a display with fully merchandised bins straight from the back room.
- Also suitable both refrigerated and dry displays and can also be used for meat, eggs and bakery products.

Item No.	Style	Dimensions	Pack
9923716096	RPC Display Bin	16" W x 24" L x 4.5" H	1
9923719852	RPC Display Bin	16" W x 24" L x 6.5" H	1

RPC bins are available in additional sizes and colors. Call for details.

Adjustable Flat Rack



Fresh-Fit® RPC Bin Accessories

Facer Plate

- Facer Plate fits over wire flat rack; prevents RPC from sliding to rack bottom
- Without Facer Plate, RPC slides to bottom and blocks air vents causing an interruption in the air curtain
- 16-gauge black powder-coated steel with 2" H lip and rust-resistant undercoating

Dividers

- Black ABS divider, splits RPC into 2 equal compartments



Divider - Width

Item No.	Style	Dimensions	Pack
9925813223	Facer Plate	24" W x 4.75" D	1
9923219252	Divider - Width	14.25" x 22"	1

** For complete use and care instructions, see <https://siffron.com/pages/e-coat-use-and-care>*

Fresh-Fit® Demi Curved-Front Bowls

- Durable, heavy-weight melamine plastic bowls in an attractive round design
- Special shape of these bowls is ideal for merchandising on mezzanine shelves, case wells and island cases
- Back of the oval is squared to maximize shelf space
- Bowl interior is smooth for easy cleaning
- Available in two styles: solid or with drain holes for misted application
- Black melamine (pictured terra cotta is available made to order, minimum quantities apply)



With Drain Holes

Solid

Item No.	Style	Dimensions	Pack
9922119905	Solid	12" W x 16" D x 3" H	1
9922116930	Solid	12" W x 14" D x 3" H	1

Additional colors can be made to order (minimum quantities apply).

Fresh-Fit® Reversible Plastic Baskets

- Create a full-looking display while reducing inventory and shrink
- Basket eliminates need for basket dummies with 2" product depth on one side and 1" product depth on reverse side
- Drain holes make these suitable for misted applications
- Angled sides create a natural basket look
- Black ABS plastic

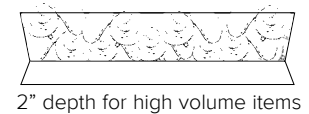

2" depth for high volume items

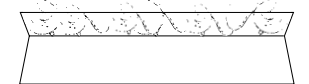

1" depth for high shrink items

Item No.	Style	Dimensions	Pack
9923013241	Reversible	12" W x 16" D x 3" H	1
9923015549	Reversible	12" W x 14" D x 3" H	1

Fresh-Fit® Vacuum-Formed Plastic Display Baskets

- Merchandise variety and specialty produce in durable plastic display baskets
- Smooth interior and exterior finish provides an easy-to-clean surface for improved sanitation at store level
- Recessed area on two sides of basket accepts sign tag clip
- Baskets stack and nest for convenient storage
- Available in several sizes with or without drainage holes
- Black vacuum-formed high-impact ABS plastic

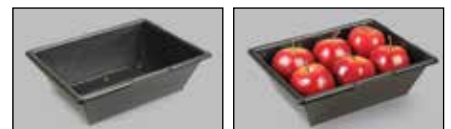

Basket with Holes

Item No.	Style	Dimensions	Pack
9923017135	Basket w/ Holes	12" W x 16" L x 3" H	1
9923015698	Basket	12" W x 18" L x 3" H	1
9923014964	Basket w/ Holes	12" W x 18" L x 3" H	1



Ideal for bakery items such as croissants, rolls, and bagels

Fresh-Fit® Pull-Out Bulk Merchandiser

- Customer-friendly merchandiser organizes produce and prevents cross-contamination
- Ideal for bulk items such as leafy greens, mushrooms, beans, peas, garlic, and bakery items
- Clear construction and pull-out drawer allow easy visibility and convenient shopping
- Attaches to most perforated produce shelving including Fresh-Fit® Thin Profile 16" shelves or deeper (fasteners included)
- Easy cleaning with two removable internal bins
- Integrated shelf glides ensure smooth operation
- Includes tongs with tether (attached to bins) for convenient customer selection; replacement Tong w/ Tether also sold separately
- Optional Dummy Riser Insert for bin
- Design and materials are NSF compliant and safe for direct food contact



Pull-Out Bulk Merchandiser

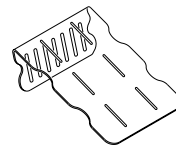

(Optional) Dummy Riser Insert



Replacement Tong w/ Tether

Item No.	Style	Dimensions	Pack
992310151	Pull-Out Bulk Merchandiser	23" W x 16.17" D x 8.5" H	1
992310152	Dummy Riser Insert	9.75" W x 13.60" D x 4.08" H	1
9922917901	Replacement Tong w/ Tether	9" L Tong / 6"- 24" Tether	1

Fresh-Fit® Single- and Multi-Compartment Merchandisers

- Merchandise and maintain freshness of delicate specialty produce varieties such as mushrooms, mesclun or endive
- Each compartment has its own hinged lid with handle and clear cover for visibility
- Tapers from 8" in back to 4" in front for optimum visibility
- 9923110275 features round silver easy-lift knobs on doors, plus two sets of tethered tongs for customer convenience
- Black plastic with clear acrylic doors

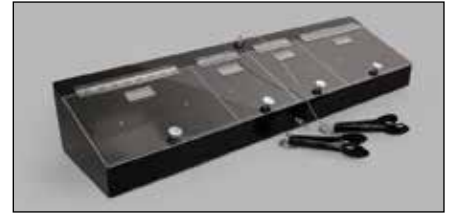

Four-Compartment with Tethered Tongs

Item No.	Style	Dimensions	Finish	Pack
9923110275	Four-Compartment, w/ Tethered Tongs	46.5" W x 12" D x 8" H x 4" H	Acrylic w/ Acrylic Doors	1

Additional sizes and colors can be made to order (minimum quantities apply).

Fresh-Fit® Shelf Organizer With Step

- Stepped design maximizes your presentation with a minimum of product, reducing shrink
- Removable divider allows for merchandising flexibility
- Clear removable front makes the display almost invisible when filled
- Black ABS plastic



One Divider



Two Dividers

Item No.	Dimensions	Dividers	Pack
9924211378	24" W x 14" D x 6" H	2	1
9924211377	24" W x 16" D x 6" H	2	1



Two-Step Tray

Fresh-Fit® Asparagus Step Tray

- Tray features a stair step design to create an attractive display using minimal product
- Watertight construction holds ice or water in base of steps
- Bundled product stands on end to prolong delicate freshness of asparagus
- Two-Step Tray fits on shelves 20" D or greater
- Three-Step Tray fits into cooler wells
- Off-season, the tray can be used for featuring brussels sprouts, fresh herbs or variety items
- Easy-to-clean one-piece design
- Vacuum-formed black ABS plastic

Item No.	Style	Dimensions	Finish	Pack
9922816276	2-Step	11.5" W x 20" D	Black	1

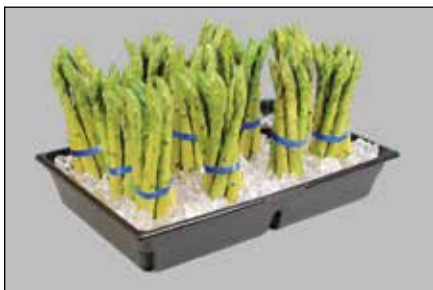

Basket with Insert

Fresh-Fit® Asparagus/Herb Merchandiser

- Merchandise asparagus, herbs and other specialty produce
- Basket features a smooth interior and exterior finish to provide an easy surface for improved sanitation at store level
- Basket holds water or ice to keep product fresh
- Recessed area on two sides of basket accepts sign tag clip
- Baskets stack and nest for convenient storage
- Insert fits securely into Basket and features 12 cut-out holes for stand-up merchandising
- Insert holes ensure product will not fall over as display is shopped
- Basket is black vacuum-formed high-impact ABS plastic
- Insert is a clear flat plastic sheet

Item No.	Style	Dimensions	Pack
9923015698	Basket	12" W x 18" L x 3" H	1
9922819440	Insert	12" W x 18" D	1

Fresh-Fit® Vacuum-Formed Herb Tray

- Organize packaged herbs attractively on cooler shelves
- Holds 16 containers
- Black vacuum-formed ABS plastic



Item No.	Dimensions	Finish	Pack
9924210001	9.5" W x 12.5" L x 1.75" H	Black	1

Fresh-Fit® Gravity-Feed Root Bin

- Bottom is adjustable and can be used flat for higher inventory or angled to facilitate first-in, first-out replenishment and keep product towards the front of the bin
- Great for merchandising root/bulk vegetables in the well of the case
- Wire front product stop provides visibility of product and matches the design of the wire product stops on the Fresh-Fit® Thin and Vertical systems
- Can be used to transport product
- Fits onto Fresh-Fit® Convertible Flat Rack or wire racks in the well of the case
- Black coated aluminum bin with removable divider; black steel wire front fence



Item No.	Dimensions	Finish	Pack
9923210513	20" D x 24" W x 8.5" H	Black	1

Fresh-Fit® Aluminum Gravity-Feed Bins

- Angled design facilitates first-in, first-out replenishment and keeps product toward the front of the bin
- Great for merchandising salad, mushrooms and specialty items
- Clear front product stop provides visibility to product
- Can be used to transport product
- Fits onto Fresh-Fit® Convertible Flat Rack
- Available in two sizes: 24" width and 12" width
- Coated aluminum for long-term solution



Item No.	Dimensions	Finish	Pack
9923110004	24" W x 22" D x 6.75" H	Black	1
9923110005	24" W x 12" D x 6.75" H	Black	1



Specifications

- Front Rail
 - Standard
 - Kwik-Connect™
 - ABS plastic
- Dividers/Pusher Tracks
 - 10", 12", 14", 16", 18", 20", 22" and 24" D
 - 2.625" and 4" H
 - Beige, black or white high-impact plastic
- Front Lens
 - 1.75", 3" and 3.875" H
 - Clear polycarbonate
- Track Lens
 - Standard Lens 1.75" W x 1.75" H
 - Wide Base Lens 1.75" W x 2.25" H
 - Clear polycarbonate

Power Zone® Kwik-Set™ Self-facing System

The Power Zone® Kwik-Set™ Self-facing System is a labor-saving, component-based merchandising system flexible enough to accommodate the widest range of product shapes and sizes throughout the store. The System provides a single solution for total shelf management. To further increase the convenience and labor savings of self-facing, the Tracks and Dividers can be easily added, removed or adjusted by sliding along Front Rail – all while product remains on the shelf.

- Dividers and Tracks engage and disengage easily for trouble-free installations and quick set changes
- Offering unlimited spacing configurations, Dividers and Tracks can be adjusted by sliding along Front Rail
- Spring-loaded lock tab allows easy adjustment of facing width, even with product in place; tab automatically locks into place, maintaining facing width integrity
- Center push configuration features separate pusher track and divider to provide consistent, center-of-product force for most packaging shapes and styles, including round and irregularly-shaped products, and minimizes need for multiple pushers on large products
- Integrated clear front lens provides unobstructed view of products
- Available with Kwik-Connect™ Front Rail to attach to shelf without the need for separate fasteners
- Compatible with all Power Zone® Sure-Set™ Paddle Extenders and Adapters
- Components can ship pre-assembled for box-to-shelf installation to minimize labor, or in bulk by category to minimize freight

May be covered under one or more system patents.



Fits a wide range of shapes and sizes



Health and Beauty



Boxed Packaging



Bagged Products

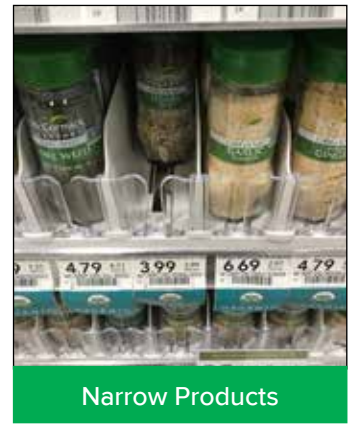

Narrow Products



Beverages



Wine and Spirits



Frozen Section



Face almost anything!



Power Zone® Kwik-Set™ Self-facing System

- Select components to create a custom solution for a variety of package shapes
- Use Paddle Extenders for extra wide, tall or heavy products

Configure your system

- A** Front Rail
- B** Dividers/Pusher Tracks
- C** Paddle Extenders and Accessories
- D** Fasteners
- E** Kits

A Front Rail*

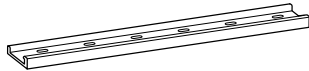

Standard Front Rail
41211000 CL

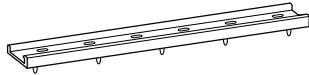

Kwik-Connect™ Front Rail
41212000 CL

Item No.	Style	Color (C)	Length (L)
41211000 CL	Standard	Beige (0), Black (2), White (3)	30" (3), 36" (1), 48" (2)
41212000 CL	Kwik-Connect™ for Lozier / Madix	Beige (0), Black (2), White (3)	30" (3), 36" (1), 48" (2)
41213000 CL	Kwik-Connect™ for Darling / Syndicate	Beige (0), Black (2), White (3)	30" (3), 36" (1), 48" (2)
6840129602	Allura™ LED Lighting for Kwik-Set™	Clear	48"

*To determine the item number, replace "C" with the corresponding Color value, and "L" with the Length value. For example, the 48" Kwik-Connect™ for Lozier/Madix in White is 412120003.

B Dividers/Pusher Tracks*

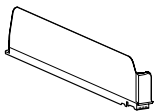

Left End Divider
41231001 CD

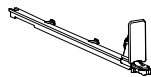

Standard Track
41280020 CD

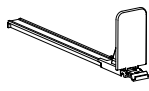

Wide Base Track
41284060 CD

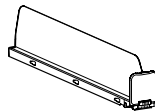

Center Divider
41232001 CD

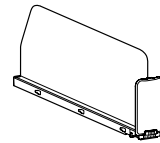

Tall Center Divider
3" H Lens
41232103 CD

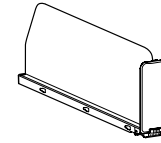

Tall Center Divider
3.875" H Lens
41232102 CD

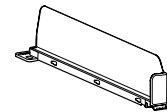

Right End Divider
41233001 CD

Item No.	Style	Size	Color (C)	Shelf Depth (D)
41231001 CD	Left End Divider	.625" W (Base) x 2.625" H	Beige (0), Black (2), White (3)	10" (0), 12" (1), 14" (2), 16" (3), 18" (4), 20" (5), 22" (6), 24"
41231103 CD	Tall Left End Divider w / 3" Lens	1.25" W (Base) x 4.375" H	Beige (0), Black (2), White (3)	10" (0), 12" (1), 14" (2), 16" (3), 18" (4), 20" (5), 22" (6), 24"
41231102 CD	Tall Left End Divider w / 3.875" Lens	1.25" W (Base) x 4.375" H	Beige (0), Black (2), White (3)	10" (0), 12" (1), 14" (2), 16" (3), 18" (4), 20" (5), 22" (6), 24"
41280020 CD	Standard Track	1.125" W x 2.5" H	Beige (0), Black (2), White (3)	10" (0), 12" (1), 14" (2), 16" (3), 18" (4), 20" (5), 22" (6), 24"
41284060 CD	Wide Base Track / M Spring	2.5" W x 4" H	Beige (0), Black (2), White (3)	16" (3), 18" (4), 22" (6), 24"
41284070 CD	Wide Base Track / X Spring	2.5" W x 4" H	Beige (0), Black (2), White (3)	16" (3), 18" (4), 22" (6), 24"
41232001 CD	Center Divider w / 1.75" Lens	1.3125" W (Base) x 2.625" H	Beige (0), Black (2), White (3)	10" (0), 12" (1), 14" (2), 16" (3), 18" (4), 20" (5), 22" (6), 24"
41232103 CD	Tall Center Divider w / 3" Lens	.625" W (Base) x 4.375" H	Beige (0), Black (2), White (3)	10" (0), 12" (1), 14" (2), 16" (3), 18" (4), 20" (5), 22" (6), 24"
41232102 CD	Tall Center Divider w / 3.875" Lens	.625" W (Base) x 4.375" H	Beige (0), Black (2), White (3)	10" (0), 12" (1), 14" (2), 16" (3), 18" (4), 20" (5), 22" (6), 24"
41233001 CD	Right End Divider w / 1.75" Lens	.625" W (Base) x 2.625" H	Beige (0), Black (2), White (3)	10" (0), 12" (1), 14" (2), 16" (3), 18" (4), 20" (5), 22" (6), 24"
41233103 CD	Tall Right End Divider w / 3" Lens	1.25" W (Base) x 4.375" H	Beige (0), Black (2), White (3)	10" (0), 12" (1), 14" (2), 16" (3), 18" (4), 20" (5), 22" (6), 24"
41233102 CD	Tall Right End Divider w / 3.875" Lens	1.25" W (Base) x 4.375" H	Beige (0), Black (2), White (3)	10" (0), 12" (1), 14" (2), 16" (3), 18" (4), 20" (5), 22" (6), 24"
4128502023	Extend-A-Track	16" D	Black	
4128202025	Slow Feed Pusher	20"	Black	
4128205025	Slow Feed Pusher	20"	Black	

*To determine the item number, replace "C" with the corresponding Color value, and "D" with the Shelf Depth value. For example, the Side Push Track/Divider in White, for a 22" deep shelf is 4128322136.

May be covered under one or more system patents.



C Paddle Extenders and Accessories

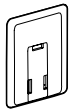

Standard Wide / Tall
4169478100



Two-Way Wide / Tall
4169478120



Graphic Holder
4169817100



Narrow / Tall
Extra / Tall
4165190341 thru
4165190342



Round / Odd Shaped
4169877702



Track Lens
4125400100



Inventory Control Unit
4168574800

Item No.	Style	For Paddle Width	Paddle Extender Size	Color
4169478100	Standard Wide / Tall	Standard Narrow Base - 1125" W	3.5" W x 4" H	Clear
4169478120	Two-Way Wide / Tall	Standard Narrow Base - 1125" W	2.75" W x 3.5" H	Clear
4169817100	Graphic Holder	Standard Narrow Base - 1125" W	1.375" W x 2.5" H	Clear
4165190341	Narrow / Tall	Standard Narrow Base - 1125" W	1.25" W x 5.5" H	Clear
4165190301	Narrow / Tall	Standard Narrow Base - 1125" W	1.25" W x 5.5" H	Beige
4165190342	Extra Tall	Standard Narrow Base - 1125" W	1.25" W x 8" H	Clear
4169877702	Round / Odd Shaped	Standard Narrow Base - 1125" W	1.90" W x 1.25" H	Clear
4125401400	V-fence			
4125401101	Angled Product Stop			
4128606026	Angled Pusher			
4125400100	Track Lens	1.75" W x 1.75" H	Clear	n/a
4125401100	Track Lens for Wide Base Track	1.75" W x 2.25" H	Clear	n/a
4168574800	Inventory Control Unit	.75" W x .875" H	Gray	n/a

*Flared Tube Adapter sizing for shelf depths, replace "D" with: (0) 10" D, (1) 12" D, (2) 14" D, (3) 16" D, (4) 18" D, (5) 20" D, (6) 22" D.

D Fasteners

Item No.	Capacity	Style	Fits
8509317101*	.25"	Standard	Perf Shelf
8502508003	.875"	Self-Threading Screw	Perf Shelf
8502508100	.125"-.1875 ID x .25" H	Black Vinyl Cap	Screw
4166734140	n/a	Wire	Wire Shelf



Standard



Self Threading Screw



Vinyl Cap



Wire

* Use five standard fasteners for 36" L fences and longer; two fasteners for 30" L and shorter.
May be covered under one or more system patents.



Kwik-Set™ Slow Feed Pusher

- Slow-Feed Pushers use a special spring dampener to decelerate the pusher and make merchandise move forward at a much slower pace than standard pusher systems.
- Ideal for stacked products, delicate products and loss prevention
- Available in 2 spring strengths; low force - 4128202025, high force - 4128205025
- Available in black and customized length



Item No.	Ref. No.	Dimensions	Finish	Pack
4128202025	PZKWIK-WSTP-SLOW-150E-20BK	20"	Black	1
4128205025	PZKWIK-WSTP-SLOW-150J-20BK	20"	Black	1



Kwik-Set™ Extend-A-Track

Extend-A-Track™ works by using a recessed paddle-pusher to allow for more merchandising space on each pusher track. This also allows for commonality across multiple shelf depths so store retailers can use the same pusher tracks (between 2" shelf depth differential). It also accommodates odd number shelf depths (13", 15", etc.), increasing merchandising efficiency.

- Available in black
- Available on 10", 12", 14", 16", 18", 20", 22" and 24" deep tracks



Item No.	Ref. No.	Dimensions	Finish	Pack
4128502023	PZKWIK-EXT-7E-16BK	16" D	Black	1



Kwik-Set™ V-Fence

The V-Fence Track Lens snaps individually on Wide Base Tracks, only where needed. Ideal for large, round products, such as paper plates. Prevents product from tipping forward.



Item No.	Ref. No.	Dimensions	Finish	Pack
4125401400	PZKWIK-WPST-225	4.5" H x 9" W	Clear	1

Angle Pusher

Pusher Track with adjustable angle paddle allow merchandising product at 15, 30 or 45 degrees. The angle prevents product from tipping forward and also product to be merchandised in limited vertical space. Use in conjunction with the Angle Track Lens for optimum performance.

- Prevents taller merchandise from tipping while being faced
- Keeps product secure
- Easy to install – just snaps onto back of FACER frame
- Available on 16”, 18”, 20”, 22” and 24” deep tracks
- Available in black and customized length

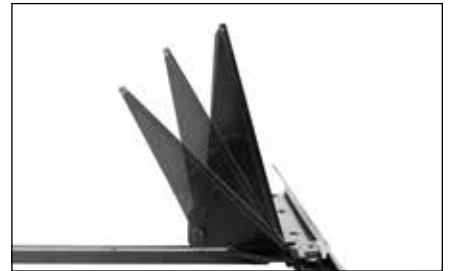

Item No.	Ref. No.	Dimensions	Finish	Pack
4128606026	PZKWIK-WADJPDL-250M-22BK	22”	Black	1
4125401101	PZKWIK-WPST-ANGL	-	Clear	1

Allura™ LED Lighting for Kwik-Set™

Allura™ LED Lighting for Kwik-Set™ integrates easily with any new or existing Kwik-Set displays. Simply snap in LED light bar into standard Kwik-set front rail. Does not require fasteners or tools. Use siffron Allura™ Bus Bar to connect to power supplies.

- Easy to install
- Highlight special products and promotions
- Powered by standard Allura bus bars
- 10 Lightbars per power supply

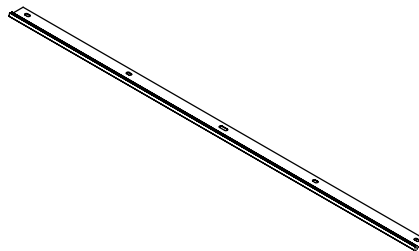

Lumen	Low Voltage	Light Color Temperature	Color Render Index	Bus Bar	Beam Width	Lifetime	Length	Waterproof	Watts
300/ft	24v	4100k	80+	Yes	120°	50k Hrs	22”	No	1.44/ft

Item No.	Description	Length	Finish	Pack Size
6840129602	48” Allura™ LED Lighting for Kwik-Set™	48” L x 1.25” H	Clear	10
UL19221446	Allura™ Ultra-Mini LED Rigid Bar	46” L	White	1



Power Zone® Pre-Set™ Self-facing System*

Delivering breakthrough results for retailers, brand marketers and consumers, the revolutionary Power Zone® Pre-Set™ Self-facing System takes merchandising, loss prevention and profits to a powerful new level. Power Zone® is the only system on the market that generates the sales boost and time- and labor-savings you're looking for, plus ships pre-assembled for fast box-to-shelf installation. And, in a recent study, Power Zone® helped a major retailer reduce inventory shrink by up to 95%[†] in key product categories.

- Ships pre-assembled and ready to place on the shelf, saving 40% or more in installation costs versus non-preassembled systems
- One-piece design allows super-fast setting and re-setting of shelves and categories
- Product is automatically advanced so every product is prominent and accessible
- Durable high-impact plastic Front Fence resists breakage and offers crystal-clear clarity, as well as deters "shelf sweeping theft"
- Track/Dividers adjust to accommodate nearly any product shape or size for a universal solution
- Attaches to shelving with fasteners, screws, or with optional adhesive
- Optional made-to-order Label Strips on Front Fence can be color-coded or printed to specifications for easy product, brand or category identification
- Optional Extend-A-Track™ paddle allows one system to fit multiple shelf depths

[†]Based on a 9-month study conducted by a major drug store chain.

*May be covered under one or more system patents.



Standard 6 Facing Kits for Salad
Includes 6.125" W Track/Dividers
(Maximum Additional Facings for 48" shelf = 1)

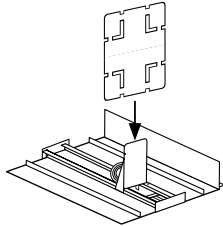

Standard 8 Facing Kits for Bagged Vegetables
Includes 3.9375" W Track/Dividers

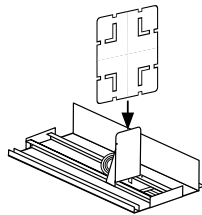

Standard 11 Facing Kits for Herbs
Includes 3.9375" W Track/Dividers
(No Additional Facings will fit on a 48" shelf)

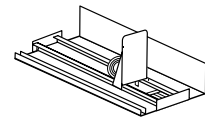

Accessories
Flip Paddle Extender to push tall or wide product

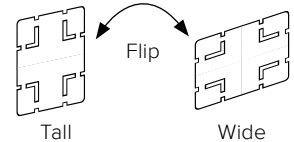

Power Zone® Pre-Set™ Self-facing System* - Kits

- Each Kit comes pre-assembled with a pre-determined amount of facings depending on the system.
- Front Fence is 3" H x 48" L
- Track/Dividers are 2.25" H
- Front Fence and Track/Divider are high-impact plastic
- Springs are stainless steel, variable force
- Additional facings are available to slide into system, sold separately
- Optional Drop-in Track serves as a second pusher to self-face wide or heavy product

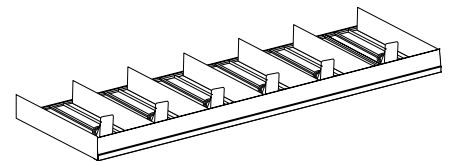

Item No.	Style	Dimensions	Finish	Pack
Standard 6 Facing Kits – 6.125" W Track/Dividers				
4176953822	Salad Kit	14" D	Black	1
4176953824	Salad Kit	18" D	Black	1
Standard 8 Facing Kits – 3.9375" W Track/Dividers				
4175801524	Bagged Vegetables Kit	18" D	Black	1
Standard 11 Facing Kit – 3.9375" W Track/Dividers				
4175801525	Herb Kit	14" D	Black	1
Accessories				
4178187203	Paddle Extender	4" W x 5" H	Black	1

Call for details. Minimum quantities may apply.
Additional sizes and configurations can be made to order.

*May be covered under one or more system patents.



[NEXT] 2.0

The next generation for organized and accessible retail display

With the NEXT® 2.0 Merchandising System, retailers save valuable retail space and can stock additional products per tray. NEXT® 2.0 offers the following features:

- The only NSF Certified tray on the market
- Attractive construction of plastic divider and pusher paddle reduces overall weight and cost
- Uniform size of pusher paddle and front product stop to maintain consistency across packages and categories
- Pusher paddles extend to the back of tray to hold more merchandise
- Divider ledge secures wide boxed and bagged products
- Durable wire frame expands from 4.6" to 11" to accommodate a wide variety of package shapes and sizes. HD Wide Trays hold even more.
- Three tray mounting styles available: bar mount, shelf rail mount and grid mount.
- Trays fit on Fresh-Fit® Thin Profile Shelving System mount bar to organize and face salads and other bagged produce

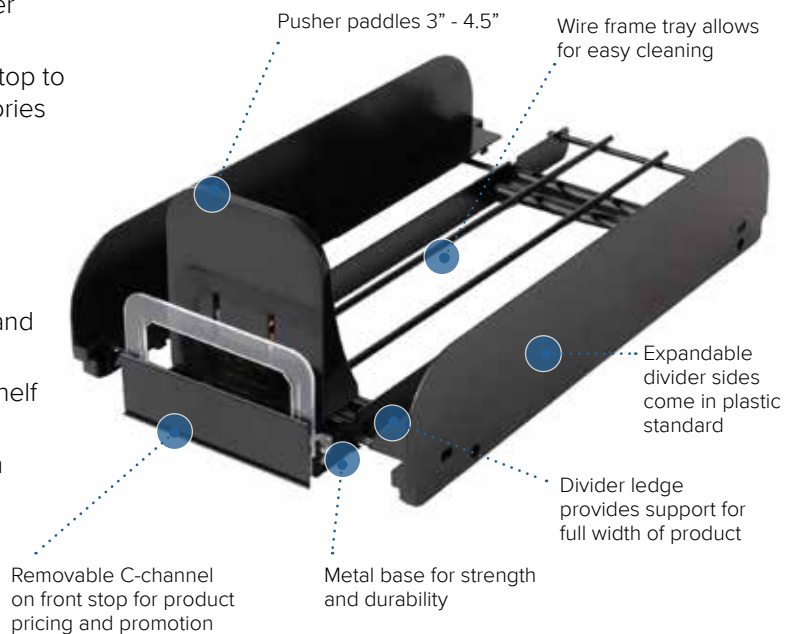



Without NEXT® products appear unorganized and unattractive. It is difficult for the consumer to find what they are looking for and to distinguish between brands.



The NEXT® System creates “product billboard”- a wall of product that enhances category and brand awareness. This helps provide better rotation for time-sensitive products.

Increase Sales

Increase sales 10-15% through enhanced product appearance. Average ROI of eight months.

Increase merchandising space

Increase the number of facings in a section by as much as 30% by removing shelves and optimizing planograms.

Reduce labor costs

Upon product removal, each product is faced with spring-loaded action.

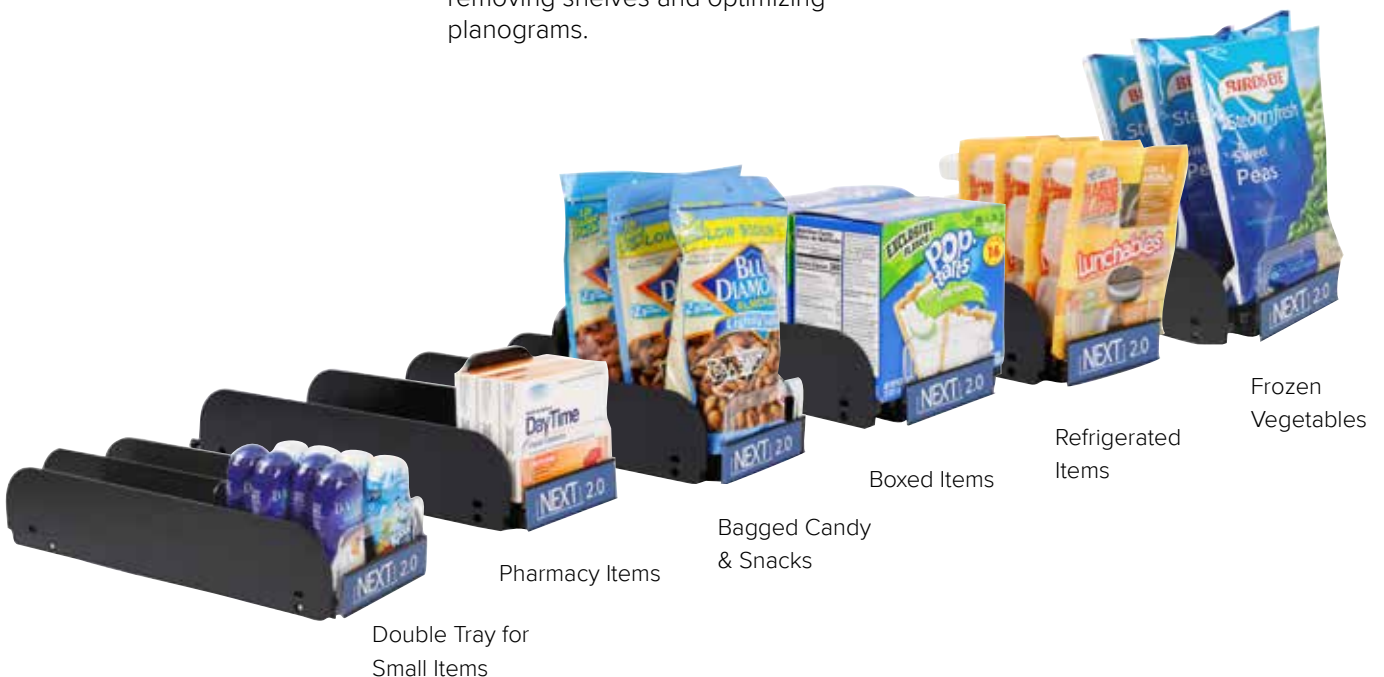

A tray size for every display

The NEXT® Tray Merchandising System allows retailers to maximize merchandising space and improve product visibility. Each item remains faced and visible to the customer for easy product selection.

By incorporating the NEXT® System into a planogram, retailers can eliminate expensive shelving and put more product in its place.

NEXT® 2.0 allows retailers to further streamline appearance and simplify labor while saving money. The pusher paddle extension allows for easy and complete product stocking.



Standard trays expand 4.6" - 11"

Accessories and Options

Flip Front Trays

The front fence folds down as it is pressed from the front to load product into the tray for an easy one-hand operation. The fence is spring-loaded to pop back up into an upright position and hold product in place as every last item is faced forward.



Double Paddle Insert

The Next® 2.0 increases product capacity with the Double Paddle Insert. Smaller products are neatly displayed and are accessible. The Double Paddle Insert is available for all tray sizes and styles. Contact siffron for a custom quote.



Organic Fence

Showcase organic products with the optional NEXT® 2.0 organic front fence. This versatile attachment replaces the standard front fence and highlights the display.



Integrated air baffles

The NEXT® 2.0 is also available with baffles to ensure temperature is maintained at the optimal level and product is kept fresh from the back of the cooler to the front. NEXT® 2.0 baffles come installed into the tray already – requiring no additional assembly. Note: NEXT® 2.0 standard version with integrated baffles can expand up to 7.75", while the HD Wide with baffles version opens 6" - 12".



LED Lighting

Looking for a way to draw customer attention to your retail space? Perfect for promoting impulse purchase items such as candy.



Under refrigeration testing, the NEXT® 2.0 has proven it supports the critical air curtain required for optimal preservation of frozen or chilled merchandise, allowing the unit to hold proper temperatures.*

*Unit must be properly installed and merchandised

NEXT® 2.0 (Bar Mount)

- Design of tray mount allows trays to span over bars, creating a continuous flow of merchandise
- Standard 4.6” wide tray frame
- 1” bar available in various lengths
- Multiple label holder options or Digital Etags available
- Universal bracket fit all uprights
- Various spring strengths and quantities can be used (available for HD Wide Trays only)
- Divider ledge provides support for full width of product
- Adjustable side dividers (custom styles available)*
- Custom front fence heights available as well as different label holder options*

*Consult manufacturer for custom options

NEXT® 2.0 Bar Tray

- Tray is available in black 13”, 15”, 17”, 19”, and 21” depths
- Bar Tray expands from 4.6” to 11” wide with dividers

NEXT® 2.0 Bar Tray with Baffles

- Baffles ensure temperature is maintained at the optimal level and product is kept fresh from the back of the cooler to the front
- Tray is available in black 15”, 17”, 19”, and 21” depths
- Bar Tray with Integrated Baffles can expand from 4.6” up to 7.75” wide

NEXT® Bar

- One bar style fits all uprights in gondolas, coolers, freezers
- Works with NEXT® trays with bar bracket holders in back
- Available in 30”, 36” and 48” lengths
- 1” square ends with mounting brackets



NEXT® 2.0 Bar Tray

PATENTED



Divider sides are expandable



NEXT® 2.0 Bar Tray with Baffles



NEXT® 2.0 Bar Tray with Flip Front Fence



NEXT® 2.0 Bar

Item No.	Ref. No.	Style	Dim.	Pack
4800520198	N2B-13-141-K	Bar Tray	13” D	12
4807248061	N2B-15-141-K	Bar Tray	15” D	12
4805400238	N2B-17-141-K	Bar Tray	17” D	12
4807046462	N2B-19-141-K	Bar Tray	19” D	12
4801312049	N2B-21-141-K	Bar Tray	21” D	12
480148346	N2B-15-141-B-K	Bar Tray w/ Baffles	15” D	12
4809674916	N2B-17-141-B-K	Bar Tray w/ Baffles	17” D	12
4808054193	N2B-19-141-B-K	Bar Tray w/ Baffles	19” D	12
4804611715	N2B-21-141-B-K	Bar Tray w/ Baffles	21” D	12
4800750013	-	Bar Tray w/ Flip Front	13” D	12
4800750015	-	Bar Tray w/ Flip Front	15” D	12
4800750017	-	Bar Tray w/ Flip Front	17” D	12
4800750019	-	Bar Tray w/ Flip Front	19” D	12
4800750021	-	Bar Tray w/ Flip Front	21” D	12
4800790015	-	Bar Tray w/ Baffles/Flip Front	15” D	12
4800790017	-	Bar Tray w/ Baffles/Flip Front	17” D	12
4800790019	-	Bar Tray w/ Baffles/Flip Front	19” D	12
4800790021	-	Bar Tray w/ Baffles/Flip Front	21” D	12
4802735329	RNB-30-BK	Bar	1” sq x 30” L	6
4809658477	RNB-36-BK	Bar	1” sq x 36” L	6
4809013742	RNB-48-BK	Bar	1” sq x 48” L	6



NEXT® 2.0 Pull-Out Tray (Bar Mount)

- Pull-Out Tray hooks directly onto either the NEXT® Bar or Fresh-Fit® Thin Profile Mount Bar Assembly
- Tray has integrated baffle
- Pull-Out Tray expands from 4.6” to 7.75” wide with dividers
- Black Pull-Out Tray extends over half of the total tray length
- Easy to load product into cooler sections
- A locking paddle makes loading and re-loading product a snap, paddle automatically releases when tray is closed
- NSF Certified



NEXT® 2.0 Pull-Out Tray

Item No.	Ref. No.	Style	Dim.	Pack
4801939559	N2E-15-142-B-K	Pull-Out Tray w/ Baffles	15” D	12
4802738587	N2E-17-142-B-K	Pull-Out Tray w/ Baffles	17” D	12
4800610704	N2E-19-142-B-K	Pull-Out Tray w/ Baffles	19” D	12
4802140945	N2E-21-142-B-K	Pull-Out Tray w/ Baffles	21” D	12

NEXT® 2.0 Shelf Mount Tray



NEXT® 2.0 Bar Tray for Shelf

NEXT® 2.0 Shelf Tray

- Standard 4.6” wide tray frame
- Tray is available in black 13”, 15”, 17”, 19”, and 21” depths
- Shelf Tray expands from 4.6” to 11” wide with dividers
- Rear shelf clip included
- NSF Certified

NEXT® 2.0 Shelf Rail

- Black Shelf Rail provides easy adjustment of installed NEXT® trays
- No un-install necessary - just slide into place
- For wire cooler shelving use Fastener for Wire 4166734140 (sold separately)
- For standard gondola metal shelving Universal Fastener push pin 8509317101 (sold separately)

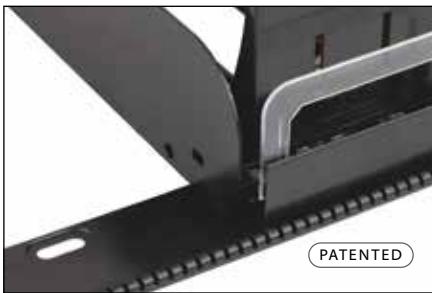

Trays lock in the front and rear for easy adjusting

Item No.	Ref. No.	Style	Dim	Pack
4805020182	N2S-13-141-K	Shelf Tray	13” D	12
4800644975	N2S-15-141-K	Shelf Tray	15” D	12
4801596127	N2S-17-141-K	Shelf Tray	17” D	12
4809362717	N2S-19-141-K	Shelf Tray	19” D	12
4802305106	N2S-21-141-K	Shelf Tray	21” D	12
4800660013	-	Shelf Tray w/ Flip Front	13” D	12
4800660015	-	Shelf Tray w/ Flip Front	15” D	12
4800660017	-	Shelf Tray w/ Flip Front	17” D	12
4800660019	-	Shelf Tray w/ Flip Front	19” D	12
4800660021	-	Shelf Tray w/ Flip Front	21” D	12
4801672654	255341-30	Shelf Rail	30” L	10
4805154594	255341-36	Shelf Rail	36” L	10
4807892604	255341-48	Shelf Rail	48” L	10
4803936544	-	Cooler Shelf Clip	4” L	200

NEXT® 2.0 Grid Mount Trays



- NEXT® 2.0 Grid Mount Trays are designed for 1" space wire display grids
- NEXT® 2.0 Grid Mount Trays are perfect for open cooler displays
- NEXT® 2.0 Grids available to mount NEXT® 2.0 Grid Mount Trays
- Pull-out version is the **only tray on the market** with full extension of the tray for easy product stocking
- Uniform size of pusher paddle and front product stop maintains consistency across packages and categories
- Pusher paddles extend to the back of tray to hold more merchandise
- Divider ledge secures wide boxed and bagged products
- Durable wire frame expands from 4.6" to 10.5" (4.6" to 7.75" with baffles) to accommodate a wide variety of package shapes and sizes
- Recommended weight: 18 lbs/tray
- NSF Certified



NEXT® 2.0 Grid Tray with Baffles



NEXT® 2.0 Pull-Out Grid Tray

Item No.	Ref. No.	Dimensions	Finish	Pack
Grid Tray with Baffles				
4804880015	N2G-15-141-B-K	4.6" W x 15" L	Black	12
4804880017	N2G-17-141-B-K	4.6" W x 17" L	Black	12
4804880019	N2G-19-141-B-K	4.6" W x 19" L	Black	12
4804880021	N2G-21-141-B-K	4.6" W x 21" L	Black	12
Pull-Out Grid Tray				
4800600015	N2EG-15-132-B-K	4.6" W x 15" L	Black	8
4800600017	N2EG-17-132-B-K	4.6" W x 17" L	Black	8
4800600019	N2EG-19-132-B-K	4.6" W x 19" L	Black	8
4800600021	N2EG-21-132-B-K	4.6" W x 21" L	Black	8
Grid				
4807440901	272235	8" H x 48" W	Chrome	5
4807441801	272236	19" H x 48" W	Chrome	5

HD wide trays expand wider and support larger products

PATENTED

Packages come in various sizes, and the NEXT® 2.0 HD Wide Trays have wider divider ledge supports to accommodate larger packages from 6" - 12". Each tray is built to support up to 25 lbs.



HD wide trays expand 6" - 12"

Wider divider ledge supports larger product sizes

Item No.	Ref. No.	Dimensions	Finish	Pack
HD Wide Bar Mount Tray				
4800070015	-	6" W x 15" L	Black	12
4800070017	-	6" W x 17" L	Black	12
4800070019	-	6" W x 19" L	Black	12
4800070021	-	6" W x 21" L	Black	12
HD Wide Bar Mount Tray with Baffle				
4808970015	-	6" W x 15" L	Black	12
4808970017	-	6" W x 17" L	Black	12
4808970019	-	6" W x 19" L	Black	12
4808970021	-	6" W x 21" L	Black	12
HD Wide Bar Mount Pullout Trays				
4808990015	-	6" W x 15" L	Black	8
4808990017	-	6" W x 17" L	Black	8
4808990019	-	6" W x 19" L	Black	8
4808990021	-	6" W x 21" L	Black	8
HD Wide Grid Mount Trays				
4801230215	-	6" W x 15" L	Black	12
4801230217	-	6" W x 17" L	Black	12
4801230219	-	6" W x 19" L	Black	12
4801230221	-	6" W x 21" L	Black	12
HD Wide Grid Mount Trays with Baffle				
4804920215	-	6" W x 15" L	Black	12
4804920217	-	6" W x 17" L	Black	12
4804920219	-	6" W x 19" L	Black	12
4804920221	-	6" W x 21" L	Black	12
HD Wide Grid Mount Pullout Trays				
4800630215	-	6" W x 15" L	Black	8
4800630217	-	6" W x 17" L	Black	8
4800630219	-	6" W x 19" L	Black	8
4800630221	-	6" W x 21" L	Black	8



Standard trays expand 4.6" - 11"



4eBin™ Gravity Bin

A bulk offering is an effective use of store space and creates differentiation. Introducing bulk bins as an easy way of enlarging or adapting your product offering to meet the needs of your local market demands.

Create destinations within your store where shoppers can engage fully with pick & mix of nuts, candies or cereals. Not only do bulk bins encourage greater interaction, they also give consumers more freedom to purchase the exact combination and quantity of the product they want.

Ecological A more “eco-friendly” way of shopping. Fewer resources are used in both transport and packaging.

Economical Lets shoppers buy their desired quantity and favorite mix.

Ergonomic A delight to handle for shoppers and store personnel alike.

Easy-Clean Revolutionary design allows for cleaning the bin without removing them from the shelf.



Revolutionary new easy-clean design



The GB4e100-12, 5L product is NSF Certified under HL Display Gilwice Sp. Z.o.o.

Why bulk bins are so effective:

- Product visibility stimulates impulse purchases
- First in / first out product guaranteed
- Ergonomic and anti-microbial pull handle provides a consumer friendly interaction
- Easy to install using a cross-bar system or your existing shelving
- Easy cleaning thanks to innovative design

Easy to
install
and
maintain!

Up to **30%**
Time Saving

(Compared to bins in the market)

4eBin™ Gravity Bin Features and Benefits

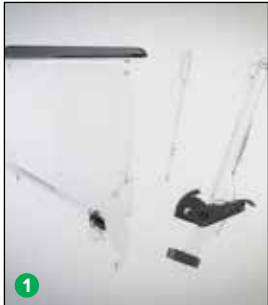

Features	Benefits
Bin fully assembled (1)	Easier mounting and dismounting
Ergonomic front cover	Easier to remove for cleaning
False front*	Bins always look full and displays the content
Dust proof lid	Designed to avoid dust / dirt traps

Features	Benefits
Smooth design of the nozzle (2)	More compact design
Ergonomic pull handle (3)	Provides a consumer friendly dispensing action
Easy refilling (4)	Removable lid with open / close function and refilling position
Stock level (5)	Remaining stock can be read from side of bin

*Optional feature to have a full face display even at low stock levels



4eBin™ Gravity Bin Specifications

- Available in 2.0, 3.3 and 5.3 gallons
- Hygienic closed system - consumers can see, but not touch the product unless buying
- All models available with or without false front depending on customer needs
- Standard flow control and ergonomic handle for optimal shopping experience and shrink reduction (first in / first out principle)
- A 5 gallon bin can sustain 44lbs of merchandise
- Transparent body; top lid, handle and sleeves are black as standard
- Additional color options available upon request
- US and European food contact certification (all bins are BPA/EA-free)
- Label printing area 5.5" W x 2.28" H (label holder for 6" wide bins)

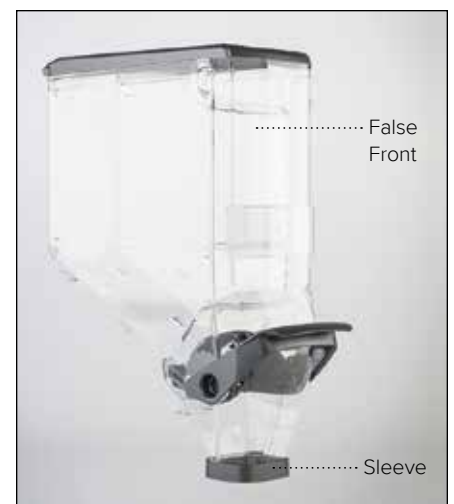

Item No.	False Front	Sleeve	Dimensions	Capacity	Pack
4630940105	Yes	Yes	3.9" W x 20.7" H x 14.6" D	2 Gal (7.5 L)	1
4639171747	Yes	Yes	3.9" W x 26.6" H x 14.6" D	3.3 Gal (12.5 L)	1
4632968055	Yes	Yes	5.9" W x 21.1" H x 13.8" D	3.3 Gal (12.5 L)	1
4639138967	Yes	Yes	5.9" W x 28" H x 13.8" D	5.3 Gal (20 L)	1

Additional sizes are available (call for details)



Crossbar with Mounting Bracket

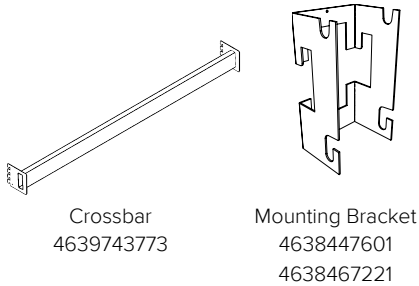

Crossbar
4639743773

Mounting Bracket
4638447601
4638467221



Crossbar with Swing Down Arm

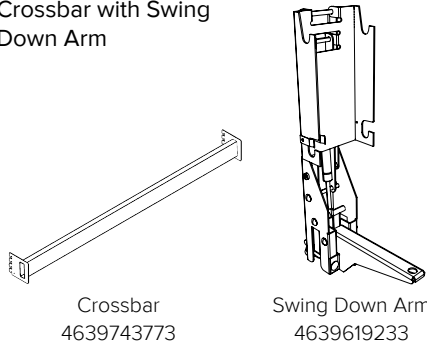

Crossbar
4639743773

Swing Down Arm
4639619233



Shelf Mount Foot with Back Rail

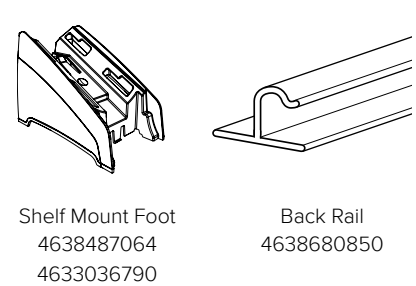

Shelf Mount Foot
4638487064
4633036790

Back Rail
4638680850

4eBin™ Gravity Bin Mounting Options

Crossbar with Mounting Bracket

- Crossbar is 48" L
- Place the mounting bracket on the crossbar and hang bin
- Install on crossbars when whole sections of bins are to be installed

Crossbar with Swing Down Arm

- Place the swing down arm on the crossbar and hang bin
- Easiest mounting method to check stock levels
- Installing swing down arms is the preferred option for upper levels

Shelf Mount Foot with Back Rail

- Foot in combination with the rail locks the bin in place
- Mounting foot will rest on shelf
- Fasten rail to back of shelf with push pins (sold separately)

Item No.	Style	Pack
4639743773	Crossbar	1
4638447601	Mounting Bracket 4"	1
4638467221	Mounting Bracket 6"	1
4638467221	Swing Down Arm 4"	1
4639619233	Swing Down Arm 6"	1
4638487064	Shelf Mount Foot 4"	1
4633036790	Shelf Mount Foot 6"	1
4638680850	Shelf Mount Back Rail	1

Additional sizes are available (call for details)



Scoop Bins

Improve customer interaction and differentiate from competitors by adding bulk Scoop Bins into your retail environment. Bulk Scoop Bins provide customers the opportunity to pick and mix various products at their discretion.

Using product scoops attached to each bin, customers can fill up as much or as little product as they require. This reduces packaging waste and ensures the displayed product is consumed without waste.

Scoop Bins grab customer attention, are easy to use, and improve overall gross margins versus similar pre-packaged products.

- Why Scoop Bins are so effective:
- Allow customers to pick and choose merchandise
- Portion control - less waste
- Easy to use
- First in / first out - guarantees freshness
- BPA/EA-free



Item No.	Style	Dimensions	Capacity	Pack
4855014827	Scoop Bin w/ sugar tray	12" W x 13.6" H x 14.8" D	5.28 G (20 L)	1
4637129392	Scoop Bin w/ sugar tray	8" W x 13.6" H x 14.8" D	3.3 G (12.5 L)	1
4633988273	Scoop Bin w/o sugar tray	8" W x 13.6" H x 14.8" D	3.3 G (12.5 L)	1
4852374281	Scoop Bin w/ divider w/ sugar tray	12" W x 13.6" H x 14.8" D	5.28 G (20 L)	1
4630828548	Scoop Bin w/ divider w/o sugar tray	12" W x 13.6" H x 14.8" D	5.28 G (20 L)	1





Scoop Bin Specifications

The angled floor of our Scoop Bins promotes automatic stock rotation to ensure product freshness and quality. Re-merchandising is done through the top which can be fully removed or just opened.

If mounted on crossbar, the Scoop Bin can be pulled out for easy refill without having to remove the bin from the fixture. The Scoop Bins are sealed and have hinged, dust-proof covers to protect merchandise from external contact.

- Scoop Bin can mount onto crossbar with brackets or onto shelf with cylindrical bumper buttons
- Available with or without divider
- Includes catch tray for easy removal of crumbs and sugar
- Use optional shutter to slow the flow and avoid accidental overfilling
- For long or otherwise cumbersome merchandise, we recommend replacing the scoop with Tongs (sold separately)
- Our Scoop Bins can be equipped with a perpendicular holder to support shelf talker or aisle sign to communicate to customers
- Transparent body; scoop and top lid black as standard
- Additional colors available on request for improved segmentation



Scoop Bin
(5.28 gallon)
4855014827

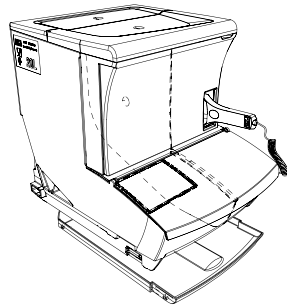

Scoop Bin with Divider
(5.28 gallon per side)
4852374281

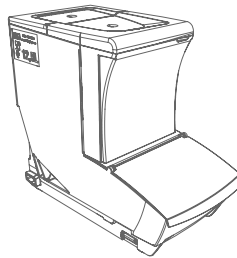

Scoop Bin
(3.3 gallon)
4633988273

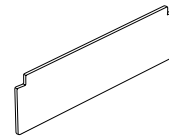

Shutter for Scoop Bin
without Divider
4856520795



Shutter for Scoop Bin
with Divider
4856166098

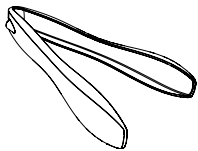

Scoop Tongs
4854994768

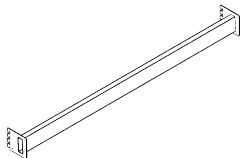

Crossbar
4639743773

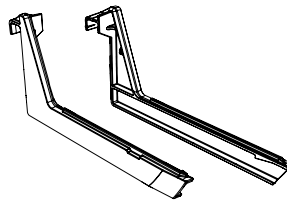

Mounting Brackets
4858644983

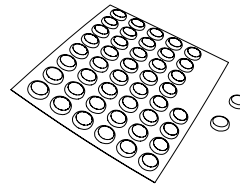

Cylindrical Bumper
8207511700

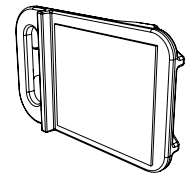

Label Holder
4854847331

Item No.	Style	Dimensions	Capacity	Pack
4856520795	Shutter for Bin w/out Divider	N/A	N/A	1
4856166098	Shutter for Bin with Divider	N/A	N/A	1
4854994768	Scoop Tongs	2.75" W x 1.25" H x 8" L	N/A	1
4639743773	Crossbar	48" W x 2.5" H	N/A	1
4858644983	Mounting Brackets	Left and Right	N/A	1 set
4854847331	Label Holder	4.1" W x 2.9" H	N/A	1



new

GoMix™ Pick & Mix Display

Improve customer interaction and differentiate from competitors with the GoMix™ Pick & Mix bulk merchandising display. Customers get a more interactive shopping experience that lets them select as much product as they want at their discretion. Retailers get the added benefit of first-in, first-out product rotation, reduced spoilage, and increased sales!

The GoMix™ Display is versatile and is easy to integrate into new or existing store planograms. It's a complete merchandising station with four shelves to display bins. GoMix™ features an assortment of scoop bins, bag holders, and other accessories which can be adapted to accommodate store needs. The base of the rack is equipped with a scrap collector to collect and hide spilled products.

- Bins pull out for easy refill, cleaning and planogram changes.
- Soft closing lid prevents lid from closing on consumers hands while shopping.
- Integrated sugar tray
- Externally placed label holder facilitates quick change of photo fronts/bin labels.
- Number of scoop and bag holders can be adapted to each store.
- Waterfall display for easy consumer access to each bin and maximum visual impact.
- Integrated scrap collector to maintain a fresh looking display. Pulls out for easy scrap removal.



Item No.	Product	Dimensions	Color
4369190008	GoMix Display	48" W x 75" H x 34" D	Orange
4369190009	GoMix Sign Holder	48" W x 15" H x 12" D	Orange
4369190010	GoMix Side Panel	31" W x 86" H	Orange
4369190011	GoMix Scoop Holder	24" W x 3" H x 4" D	Transparent
4369190012	GoMix Scoop	2.5" W x 5" H	Transparent



Self Centering

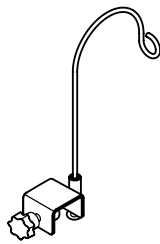

9925417222

Metal Cross Merchandiser

- Boost impulse and complementary item sales with cross merchandisers designed for placement on fixtures
- Ideal in fresh areas, including produce fixtures
- Available in five styles for use with peg hooks or merchandising strips
- All screw mount base styles fit fixtures and bins .75" to 1.25" thick; screw mount tightens onto fixtures for a secure fit and plastic coated foot protects fixture finish
- Black metal



Hanger



9925417223

Self-Centering

- Open-end hook for item display
- Protective swivel mount for safety and protection of fixture
- For use with double-sided merchandising strips



Adjustable Height

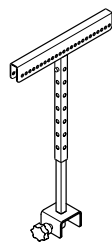

9925417225

Hanger

- Displays merchandising strips
- For use with single-sided merchandising strips

Adjustable Height

- Adjusts 12" to 18" H for ideal viewing height
- Use with Wire Peg Hooks to merchandise product (sold separately, below)
- Peg Hooks can be used on one or both sides of unit

Adjustable Height/Angle

- Angle adjusts to 30° and height adjusts 12" to 18" H for ideal viewing
- Use with Wire Peg Hooks to merchandise product (sold separately, below)
- Peg Hooks can be used on one or both sides of unit



Adjustable Height/Angle

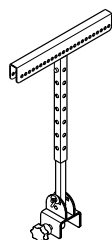

9925417226

Tabletop Adjustable Height

- Adjusts 12" to 18" H for ideal viewing height
- Use with Wire Peg Hooks to merchandise product (sold separately, below)
- Peg Hooks can be used on one or both sides of unit
- Base for flat surfaces can be secured using fasteners in four integrated mounting holes (fasteners not included)



Tabletop Adjustable Height

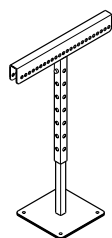

9925417227

Wire Peg Scan Hook

- Use to merchandise product on the Adjustable Height, Adjustable Height/Angle, and Tabletop Adjustable Height Merchandisers
- Fits securely into integrated peg holes
- 4" L, 7-gauge wire
- Black metal

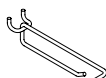

Wire Peg Scan Hook
9925417224

Item No.	Ref. No.	Style	Finish	Pack
9925417222	-	Self Centering	Black	1
9925417223	-	Hanger	Black	1
9925417225	-	Adjustable Height	Black	1
9925417226	-	Adjustable Height/Angle	Black	1
9925417227	-	Tabletop Adjustable Height	Black	1
9925417224	-	Wire Peg Hook	Black	1

Additional sizes and colors can be made to order (minimum quantities apply).

Metal Cross Merchandiser - Sign Holders

- Display pricing and promotional messages on Metal Cross Merchandisers
- Choose from a variety of styles

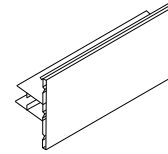

Snap-Lock™ Label Holder

- Clear covered-face protects paper signs and pricing
- Fits Wire Peg Scan Hook (9925417224)
- Holds 1.25" H x 2" L paper tickets
- Clear PVC

Item No.	Ref. No.	Holds	Fits	Pack
4402719001	R35L-2	1.25" H x 2" L	7-Gauge Wire	1

SuperGrip® Sign Holder with Hinge

- SuperGrip® brand technology holds signs in position
- Flexible hinge allows sign holder to flex when bumped
- 3" L, holds material up to .100"
- Clear PVC with magnetic strip on base

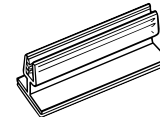

Item No.	Ref. No.	Dimensions	Capacity	Pack
2112624102	RF62-028-3	3" L	.100"	1

SuperGrip® Square Edge Sign Holder

- Features SuperGrip® gripping fins for maximum holding power
- Fits onto top of Metal Cross Merchandiser
- 3" L, holds material up to .125" thick
- Clear PVC

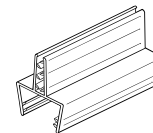

Item No.	Ref. No.	Dimensions	Capacity	Pack
1811600901	-	3" L	.125"	1

Swivo•Clamp™ Sign Holders

- Universal knuckle tilts in any direction
- Plastic spring for use in misted environments
- Clip lined with anti-slip coating
- Fits onto top of Metal Cross Merchandiser
- Clear or black plastic

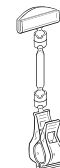
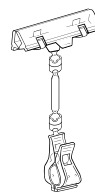

9920715453

9920715452

2809254002

2809161019

Item No.	Ref. No.	Dimensions	Capacity	Finish	Pack
9920715453	-	6.25" L	.25"	Black	1
9920715452	-	6" L	.008"-.020"	Black	1
2809254002	-	4" L	.008"-.020"	Clear	1
2809161019	-	4.5" L	.125"	Clear	1

SIGN HOLDERS



Angled Molding Clip

- Molding Clip fits securely into 1.25" H shelf channels and angles tag up for best shopper viewing angle
- Use to display pricing and promotional signage on mezzanine shelves and more
- Black plastic

Item No.	Dimensions	Finish	Pack
9920718905	1.25" H x 48" L	Black	1

Additional sizes and colors can be made to order (minimum quantities apply).



Covered-Face Sign Holder for Square Edge

- Covered-face sign holder easily clips onto tables
- Fits table and square edges .5" to .75" wide
- Holds and protects signs 3.5" H
- Available in 5.5" or 46.5" L
- Clear PVC

Item No.	Dimensions	Finish	Pack
1507632202	3.5" H x 5.5" L	Clear	1
1507632201	3.5" H x 46.5" L	Clear	1

Additional lengths can be made to order (minimum quantities apply).

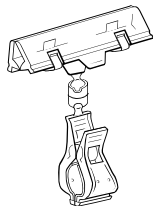

Swivo•Clamp™ Wide Sign Holder 4022

- Perfect when you need a stronger grip on your signs
- Universal knuckle tilts materials in any direction
- Extra-firm grip sign holder, 3" W
- Clip lined with anti-slip coating
- Clear knuckle style provides a clean look
- Available with metal spring, or plastic spring for misted environments
- Fits on fixtures up to 1.125" thick
- Displays material up to .25" thick
- 4" overall length
- Clear or black plastic

Item No.	Ref. No.	Spring	Style	Pack
2807818801	RSC-0007	Metal	White Knuckle	1
2807818806	-	Metal	Clear Knuckle	1
2805693105	-	Clear Plastic	White Knuckle	1
2805693108	-	Clear Plastic	Clear Knuckle	1
9920715454	-	Black Plastic	Black Knuckle	1

Swivo•Clamp™ Extended Sign Holder 1602

- Display signs above a variety of fixtures
- Universal knuckles allow you to tilt and rotate the bottom and the top
- Clip lined with anti-slip coating
- Clear knuckle style provides a clean look
- Available with metal spring, or plastic spring for misted environments
- Clip grips materials up to .125" thick
- Displays material from .008" to .020" thick
- 2" extender; 6" overall length
- Clear or black plastic with clear sign holder

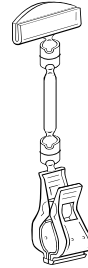

Item No.	Ref. No.	Spring	Style	Pack
2806355301	-	Metal	White Knuckle	1
2806355304	RSC-0006	Metal	Clear Knuckle	1
2807778501	-	Clear Plastic	White Knuckle	1
2807778502	-	Clear Plastic	Clear Knuckle	1
9920715452	-	Black Plastic	Black Knuckle	1

Swivo•Clamp™ Extended Wide Sign Holder 1605

- An extra-firm grip sign holder with extender
- Universal knuckles tilt and rotate at bottom and top
- Clip lined with anti-slip coating
- Clear knuckle style provides a clean look
- Available with metal spring, or plastic spring for misted environments
- Fits on fixtures up to 1.125" thick
- Displays material up to .25" thick
- 1.75" extender; 6.25" overall length
- Clear or black plastic

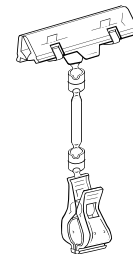

Item No.	Ref. No.	Spring	Style	Pack
2804096101	RSC-0008	Metal	White Knuckle	1
2804096111	-	Metal	Clear Knuckle	1
2803228301	-	Clear Plastic	White Knuckle	1
2803228302	-	Clear Plastic	Clear Knuckle	1
9920715453	-	Black Plastic	Black Knuckle	1



Orchard Bin, Beadboard Style



Multi-Bin Merchandiser

Wood Display Fixtures

- Attractive wood display fixtures maximize merchandising space
- Orchard Bins and Island Tables can be used as an individual fixture or multiple units for larger, permanent displays
- Produce market feel with a natural wood look
- Great for cross-merchandising
- Create an appealing tiered display anywhere in the store
- High-quality wood construction for a durable, upscale display
- Minimum quantities apply



Bin Liner and Base for Corrugated Bin Displays

- Create an impressive display for high-volume locations or larger products
- The bin liner maintains a high-volume image, while reducing spoilage due to poor rotation and crushing weight damage
- Optional bin base raises corrugated bins off the floor to reduce moisture problems and deterioration
- Can be used indoors or outdoors to provide a neat appearance and eliminate the need for pallets
- Bin base is pallet jack and fork lift accessible
- Black plastic



Standard Bin Liner



Bin Base

Item No.	Style	Dimensions	Pack
9923215339	Standard Bin Liner	47" L x 39.5" W x 5" D	1
9923212525	Bin Base	47" L x 39.5" W x 5" H	1
9923214214	Bin Liner with Riser	47" L x 39.5" W x 9" H	1

Mobile Ice Bin Merchandiser

- Create a shopping destination in store for seafood and promotional items
- Ice bin keeps product at a safe temperature
- Black ABS liner features a drain for water removal and easy cleaning
- Integrated covered sign holder holds signs 3” H x 20” L
- Great for wet or dry products
- Small and compact for reduced aisle space
- Black ABS



Item No.	Dimensions	Finish	Pack
9923110300	20” W x 20” L x 36” H	Black	1

Regency Three-Basket Mobile Merchandiser

- Ornate scrollwork and copper hammertone finish define this upscale merchandiser
- Three tiers of wicker baskets create an appealing presentation
- Kit includes metal stand with locking casters, three wicker baskets with clear liners and one 11” x 14” sign frame
- Clear plastic liners protect product from damage
- Black plastic dummy insert can be used with clear liner for a fuller look with less product
- Baskets are 16” diameter x 7” D rustic willow, with clear plastic liners



Dummy

Item No.	Style	Dimensions	Pack
9923213557	Copper hammertone stand	52” Frame	1
9923017756	Round Basket	16” dia x 7” D	1
9923010570	2.25” H Dummy for Round Basket	16” dia	1

Three-Basket Mobile Merchandiser

- Effectively display showcase items on this attractive mobile stand
- Three tiers of wicker baskets securely display product
- 9923216365 features 16” diameter x 7” D rustic willow round baskets with clear plastic liners; clear plastic liners protect product from damage
- Black plastic dummy insert for round baskets can be used with clear liner for a fuller look with less product
- Black finish; includes 11” H x 14” W sign frame
- Overall dimensions: 22” W x 52” H



Dummy

Item No.	Style	Dimensions	Pack
9923216365	Rustic Willow stand	52” Frame	1
9923017756	Round Basket	16” dia x 7” D	1
9923010570	2.25” H Dummy for Round Basket	16” dia	1

WICKER BASKET DISPLAYS



RSC-0007 Clips onto Basket

Wicker Basket Displays – Floor Stands

Versatile stand configurations are available to meet a wide variety of store needs. Display stands are designed for wicker baskets to drop right into place. No additional components or fasteners necessary. Wicker Basket Displays can be disassembled quickly and knock down for easy storage and shipping. Units are packed 1 per box and are dishwasher safe for easy cleaning.

- Multi-tiered (2 or 3 levels)
- Sturdy wire-formed structure
- Brown synthetic wicker baskets
- Great for impulse buy displays
- Baskets are food grade quality and dishwasher safe
- Square baskets are 13" L x 13" W x 4" D
- Round baskets are 15" dia x 4" D
- A variety of Swivo•Clip™ Sign Holders are available (call for details)
- Custom Wicker Basket Display are available (call for details)

Item No.	Ref. No.	Style	Overall Dimensions	Pack
7704590673	RWKR-3TSF	3-Tier Square	38" H x 13.5" W x 16" D	1
7701462438	RWKR-3TRF	3-Tier Round	38" H x 15" W x 16" D	1
7707461315	RWKR-2TRF	2-Tier Round	26.8" H x 15" W x 16" D	1

Wicker Basket Displays – Counter Displays

Single-piece counter top wicker basket displays are also available. These smaller displays work particularly well for convenience stores when promoting produce, sandwiches, or other perishable items.

- Versatile basket options
- Natural-looking display
- Perfect for smaller promotions
- Brown synthetic wicker baskets
- Baskets are food grade quality and dishwasher safe
- RWKR-1TSCL Basket is 24" L x 14" W x 3" D
- RWKR-1TSC Basket is 14" L x 10" W x 3" D
- RWKR-2TSC Baskets are 14" L x 10" W x 4" D



Item No.	Ref. No.	Style	Overall Dimensions	Pack
7706506056	RWKR-1TSCL	1-Tier Large Rectangle	9" H x 24" W x 16" D	1
7709579343	RWKR-1TSC	1-Tier Rectangle	7" H x 14.5" W x 16" D	1
7701903128	RWKR-2TSC	2-Tier Rectangle	16.6" H x 14.5" W x 16" D	1

Wicker Basket Displays – Liners

Clear plastic liners for wicker baskets are also available for fast clean-up. Some types of merchandise (fresh produce) can leave behind residue or other particulates. Plastic liners fit snugly within the wicker baskets and do not detract from store branding or basket display. To clean, simply remove merchandise and plastic liner, use siffron's Power Clean solution on a clean paper towel for safe, effective cleaning.

- Protects basket display integrity
- Easily removable
- No extra fasteners required
- Hygienic and food-grade quality
- Use Round Liner with 2-Tier and 3-Tier Round Baskets
- Use Large Rectangle Liner with 1-Tier Large Rectangle Basket
- Use Rectangle Liner with 1-Tier Rectangle and 2-Tier Rectangle Baskets
- Use Square Liner with 3-Tier Square Baskets



Item No.	Ref. No.	Style	Dimensions	Finish	Pack
7709415725	RWKR-LNR15	Round	15" dia x 3" D	Clear	10
7703879863	RWKR-LNR2414	Large Rectangle	23" L x 12" W x 3" D	Clear	10
7707248386	RWKR-LNR1411	Rectangle	12" L x 9" W x 3" D	Clear	10



Assorted Rattan Baskets

- Baskets can be used for décor or display to create a European market look
- Round and Oval baskets available in multiple sizes
- Rattan

Item No.	Style	Dimensions	Finish	Pack
9923010724	Oval Basket w/ Handles	19" x 16" x 13.5"	Natural	1
9923014838	Round Basket w/ Handles	21.5" dia x 12.5" H	Natural	1
9923012633	Oval Basket w/ Handles	18" x 9" x 2.5"	Natural	1

Additional sizes can be made to order (minimum quantities apply).



Rattan Baskets and Liners

- Rattan Baskets are the ideal way to merchandise fresh product
- Makes a dramatic display and a natural “earthy” presentation
- Clear plastic basket liners also available; order 1 to receive a pack of 25

Item No.	Style	Dimensions	Finish	Pack
9923019598	Basket w/ Handles	13" W x 17" L x 3" H	Natural	1
9923017798	Basket w/ Handles	18" W x 24" L x 4" H	Natural	1
9923019597	Basket w/o Handles	13" W x 17" L x 3" H	Natural	1
9923017799	Basket w/o Handles	18" W x 24" L x 5" H	Natural	1
9923019601	Basket w/o Handles	13" W x 17" L x 3" H	Tea-Stained	1
9923019602	Basket w/o Handles	18" W x 24" L x 5" H	Tea-Stained	1

Additional sizes can be made to order (minimum quantities apply).



Synthetic Baskets

- Long-life baskets can be washed for improved sanitation and re-used for cost savings
- Available in multiple styles and sizes
- Brown synthetic wicker

Item No.	Style	Dimensions	Pack
9923011847	Tapered	17" W x 24" L x 4" - 9" H	6
9923011870	Tapered	17" W x 48" L x 4" - 9" H	6
9923011839	Tapered	15" W x 16" L x 4" - 9" H	1
9923019347	Tapered	16" W x 16" L x 3" - 5" H	1
9923010055	Non-Tapered	11" W x 8" L x 3" H	1

Additional sizes can be made to order (minimum quantities apply).



Synthetic Black Basket

- Attractive basket enhances product display
- Wire reinforced, with double-wrapped edges; dishwasher safe
- Durable, black synthetic wicker

Item No.	Dimensions	Finish	Pack
9923013167	12" W x 10" L x 2" H	Black	1
9923010656	12" W x 12" L x 2" H	Black	1
9923010907	8" W x 11" L x 3" H	Black	1
9923013169	7.5" W x 10" L x 4" H	Tan	1
9923011134	16" W x 11" L x 3" H	Black	1
9923010976	26" W x 18" L x 4" H	Tan	1
9923018692	16" W x 12" L x 2.5" H	Black	1

Additional sizes can be made to order (minimum quantities apply).

Slatted Three-Piece Nested Wood Crate Set

- Be creative by constructing interesting floor displays, or use as décor on top of cases
- Three crate set “nests” together
- 9923413654 and 9920215808 – Set of 3 includes:
 - Large crate: 21” L x 16.25” W x 12” H
 - Medium crate: 19” L x 14” W x 12” H
 - Small crate: 17” L x 12” W x 12” H
- Wood in African Limba or Cocoa Maple finish



African Limba



Cocoa Maple

Item No.	Dimensions	Finish	Pack
9923413654	Set of 3	African Limba	1 Set
9923019410	Large	African Limba	1
9920215808	Set of 3	Cocoa Maple	1 Set
9920215801	Large	Cocoa Maple	1

Apple Crates

- Create a country market stand look with heavy-duty crates
- Each crate is constructed of solid pine for strength and durability
- Available with FDA-approved African Limba for a contemporary look
- Reversible false bottom (3” to 5” depth) also available to reduce shrink and create a well-stocked presentation using minimal product; call for details



Item No.	Dimensions	Finish	Pack
9920215806	19” L x 12.25” W x 11.5” H	African Limba	1

Additional sizes and colors can be made to order (minimum quantities apply).

Bulk Food Barrel

- Rustic barrels have unlimited merchandising potential
- Optional plastic barrel liner creates a false bottom
- Reversible barrel has a 1.5” recessed bottom that can be used as a shallow shelf when turned upside down
- 9920219861 works on deeper side of reversible barrel
- Real wood barrel is very durable



Item No.	Style	Dimensions	Pack
9920213776	Reversible Barrel	18” dia x 30” H	1
9920219861	Liner	5 Gallon	1

Additional styles, sizes and colors can be made to order (minimum quantities apply).



Melon Cutter

- Cutter produces a crinkle-cut design for a more attractive presentation
- Sturdy stainless steel tabletop model is long lasting and easy to use
- 8.5" blade

Item No.	Dimensions	Finish	Pack
9922915430	11" W x 11" H x 10" D	Stainless Steel	1

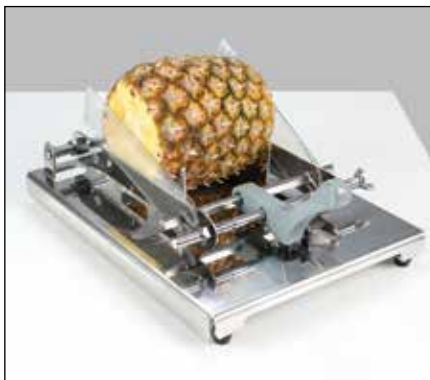

The Perfect Pineapple Cutter

- Perfect pineapple cutter gives a consistently straight cut on the top and bottom of each pineapple
- Adjustable to fit most pineapples and reduce waste
- Use with Table Top Pineapple Peeling & Coring Machine (below)

Item No.	Dimensions	Finish	Pack
9922912553	10.75" W x 14.25" D	Stainless Steel	1



Table Top Pineapple Peeling & Coring Machine



- The ultimate machine for peeling and coring whole fresh pineapple
- Springs on handle prevent it from falling when released and help return handle to the raised position after the pineapple is peeled and cored
- Push rod with handle allows for safe and easy removal of core
- Suction cups on all four corners provide added stability
- Blade for #8-10 size pineapple included (9922917170)
- Made of aluminum and stainless steel for rust-resistance

Item No.	Style	Dimensions	Finish	Pack
9922913010	Corer	10" W x 15" L x 22" H	Stainless Steel/ Aluminum	1
9922915951	Blade for #12 size pineapple	3.5" OD	Stainless Steel	1
9922917170	Blade for #8-10 size pineapple	4" OD	Stainless Steel	1
9922918790	Blade for #4-5 size pineapple	4.5" OD	Stainless Steel	1

Hanging Scale with Pan

- Scale with double-sided 8" dials hangs exactly where needed
- Measures up to 20 lb
- Stainless steel pan is USDA-approved



Item No.	Capacity	Finish	Pack
9925614287	20 lb x 1 oz	Stainless Steel	1

Escali Portion Control Scale

- Scale includes additional display on back of unit
- Measures up to 33 lb in 0.1 ounce increments
- Removable platform for easy cleaning
- Uses 9 volt AC adapter
- Available as a kit with the scale and power adapter, or scale and power adapter as individual components
- 13.25" L x 11.5" H x 5" W
- Stainless steel
- NSF Certified



Item No.	Style	Capacity	Pack
9925610001	Scale w/ Power Adapter	33 lb x 0.1 oz	1
9925610002	Scale	33 lb x 0.1 oz	1
9925610003	Power Adapter	n/a	1



Dial Platform Scales



- Platform scale for heavier-duty applications
- Three styles measure up to 20 lb, 25 lb or 30 lb in integrated 5 qt bowl
- Easy-to-read 30° tilt dial
- Removable platform for easy cleaning
- NSF Certified

Item No.	Dimensions	Finish	Pack
9925611618	20 lb x 1 oz	Stainless Steel	1
9925616206	25 lb x 1 oz	Stainless Steel	1



Roll Bag Holders

- Bag holders to meet every produce and bulk food merchandising need
- Select from floor stand or wall mount styles
- Floor model has heavy weighted square base to prevent tipping



Item No.	Style	Dimensions	Finish	Pack
9925019241	Straight Floor Model	42" H x 16" base	Black	1
9925014009	Front Mount Wall Rack	16" L	Chrome	1

Additional styles can be made to order (minimum quantities apply.)



Bouquet Bag Holder

- Stand holds standard 14" wide bouquet bags for easy customer self-service
- Available with casters for easy mobility
- Includes wire ring sign holder to display product and price information
- 9923419156: Base measures 23" x 23"
- Black metal holder

Item No.	Style	Dimensions	Pack
9923419156	Stand w/ Casters	48.5" H	1
9923418879	Stand w/o Casters	49" H	1

Regency Floral Bouquet Display Cart

- Regency-style bouquet display is a beautiful merchandiser for floral departments or anywhere fresh-cut bouquets are sold
- Floral cart features ornate decorative scrollwork and holds 12 black 13" bucket vases (included)
- Buckets angle forward for full view of blooms
- Copper hammertone finish provides upscale look



Item No.	Style	Dimensions	Pack
9923415944	Display Cart	48.5" H x 29" L x 23" W	1
9923411931	Replacement Vases	7.75" dia x 13" H	6

Black Six-Vase Flower Cart

- Sell fresh flower bouquets in any department of the store
- Four casters allow easy mobility; two locking casters keep display in place
- Comes with six black plastic floral buckets, 10" H x 9" diameter
- Included sign holder with stem holds 7" H x 11" W punched sign
- Durable, black powder-coated steel



Item No.	Style	Dimensions	Pack
9923416166	Flower Cart	44" H x 19" L x 22" W	1
9923416747	Replacement Buckets	9" dia x 10" H	6

Mobile European Flower Cart

- Increase impulse flower sales with this attractive display
- Holds five galvanized floral vases, 12" H x 7" diameter and five black plastic liners (included)
- Casters allow for mobility, while two casters lock to keep display in place
- Telescopic 7" H x 11" W sign frame clamps to top rail and adjusts from 12" to 18" height
- Folds flat for shipping
- Vase, black plastic vase liners and sign holder are included
- Plastic vase liners sold separately as replacements: 9923416431
- Galvanized metal



Item No.	Style	Dimensions	Pack
9923412247	Flower Cart	20" W x 38" H	1
9923416431	Replacement Liners	7" dia x 10" H	5
9923411738	Replacement Bucket	7" dia x 12" H	1

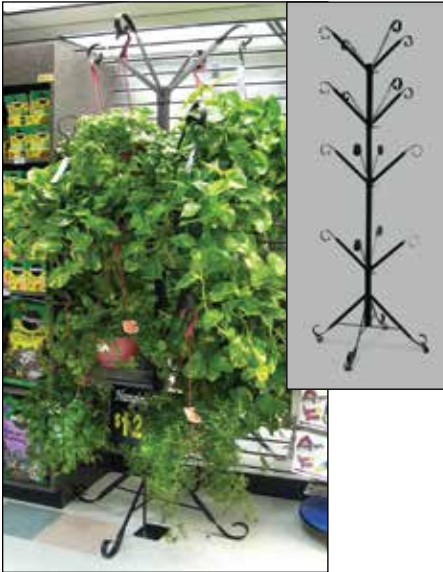

Hanging Plant Tree

- Attractively displays 16 hanging baskets within easy reach of customers
- Available with or without 11" x 14" sign frame; sign frame stem slides securely into top center post of tree
- Optional casters make it easy to move anywhere in store
- Minimal assembly required
- Stands 88" tall with a 36" diameter base
- Black heavy-gauge welded metal in wrought iron style

Item No.	Style	Finish	Pack
9923412466	Tree w/o Casters, w/o Sign Frame	Black	1



Stackable Display Cubes

- Create eye-catching floral displays with our stack and nest display cubes
- Large cube (9923416368) has non-skid feet on bottom to keep display from sliding or shifting on floor
- One-piece, injection-molded, high-impact plastic
- Black or brown



Item No.	Dimensions	Finish	Pack
9923418964	12" L x 12" W x 6" H	Black	1
9923416368	12" L x 12" W x 11" H	Black	1
9923418664	12" L x 12" W x 11" H	Brown	1
9923418665	12" L x 12" W x 11" H	Metallic Grey	1

Additional sizes and colors can be made to order (minimum quantities apply).

Slatwall Shelf

- Uniquely designed to fit into slatwall fixture to provide added merchandising space
- Display plants, floral arrangements and novelty items
- Made of durable .125" clear plastic



Item No.	Dimensions	Finish	Pack
9923419691	14" L x 14" W	Clear	1

Additional sizes can be made to order (minimum quantities apply).

Two-Way Sign Clip

- Crystal-clear holder clips onto bowls, vases, or anything up to .43" thick
- Holds signs up to .040" thick
- Use with floral buckets and vases
- Clear PVC



Item No.	Dimensions	Finish	Pack
2801986042	.75" W x 1.5" L	Clear	1

Swivel Clip Sign Holder

- Covered face, side load holder keeps signage secure when handled
- Swivel feature has limitless attachment points and multiple viewing angles
- Clear acrylic window provides a crystal-clear view of sign
- Clip engineered to minimize stress on consumer goods
- Fits onto materials up to .375" thick
- Holds 1.25" H x 2.5" L signs
- Use with floral buckets and vases
- Clear polycarbonate

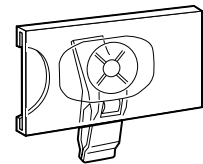

Item No.	Dimensions	Finish	Pack
1506217601	1.25" H x 2.5" L	Clear	50

Plastic Card Rack

- Black plastic holder with 12 slots holds up to 50 cards per slot
- Low profile allows for clear view of department



Item No.	Style	Dimensions	Pack
9923412973	Gift Card Rack	16" L x 7" W x 3.5" H	1

CUTTERS

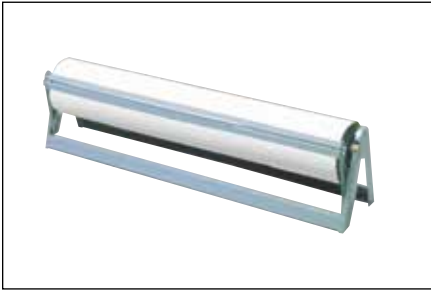

Paper Cutter

- Can be mounted on wall, under counter or on counter-top (mounting hardware is not included)
- 30" gray cutter can hold a 9" diameter roll

Item No.	Style	Dimensions	Pack
9925417082	Paper Cutter	30" L	1

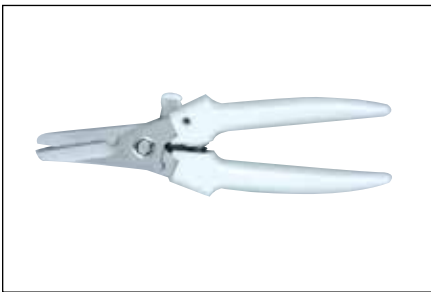

Floral Cutter

- Stainless blade cuts through many types of material; great for underwater use
- Locks shut when not in use
- White comfort-grip handles

Item No.	Style	Dimensions	Pack
9923413464	Floral Cutter	7.5" L	1



Big Bunch Cutter

- Time-saving cutter features a curved laser-edged steel blade, cutting floral stems with minimal effort
- Leverage handle has comfort grip and safety latch
- Black cutter with stainless blade

Item No.	Dimensions	Finish	Pack
9923417543	24" L x 7" H	Black	1

Octagonal Floral Vases

- Unique octagonal shape provides visual interest
- 10" H bucket has a top diameter of 5.75" and tapers to a 4" diameter bottom
- 13" H bucket has a top diameter of 6.25" and tapers to a 4" diameter bottom
- Black easy-to-clean, high-impact, leak-proof plastic
- Vases are sold only in packs of 6; order 1 to receive 6 vases



Item No.	Dimensions	Finish	Pack
9923419611	5.75" dia x 10" H	Black	6
9923419051	6.25" dia x 13" H	Black	6

Additional sizes and colors can be made to order (minimum quantities apply).

Two-Piece Floral Vases

- Tapered cone vase is available with or without stand
- Black easy-to-clean, high-impact, leak-proof plastic
- Vases are sold only in packs of 6; order 1 to receive 6 vases



Item No.	Style	Dimensions	Pack
9923418869	Vase w/ Stand	7.75" dia x 13" H	6
9923411931	Vase w/o Stand	7.75" dia x 13" H	6
9923411306	Vase w/o Stand	8.5" dia x 16" H	6

Additional sizes and colors can be made to order (minimum quantities apply).

Plastic Display Buckets

- Bucket style vase can be used for bulk storage or temporary fresh flower display
- Black easy-to-clean, high-impact, leak-proof plastic
- Buckets are sold only in packs of 6; order 1 to receive 6 vases



Item No.	Dimensions	Finish	Pack
9923410337	8" dia x 8.5" H	Black	6
9923416747	9" dia x 10" H	Black	6
9923413037	10.5" dia x 13" H	Black	6
9923412977	12" dia x 16" H	Black	6

Additional sizes and colors can be made to order (minimum quantities apply).



Round Tin Vase

- Aged copper-look finish gives floral displays a natural antique feel
- Recommended for indoor use only
- Watertight construction for use with fresh cut displays
- Tin

Item No.	Dimensions	Finish	Pack
9923410022	8" dia x 16" H	Aged Copper-Look	1



Copper Floral Buckets

- High-quality floral buckets in bright copper hammertone finish
- Each bucket includes a black plastic reusable liner
- The "shipper" bucket can accommodate floral supplier shipment buckets as liners



Item No.	Style	Dimensions	Pack
9923412363	"Shipper" Bucket w/ Liner	11" dia x 13" H	1
9923411395	Tall Bucket w/ Liner	8.5" dia x 16.5" H	1

Additional sizes and colors can be made to order (minimum quantities apply).



Galvanized Floral Buckets

- Floral bucket is galvanized for attractive floral display
- For fresh-cut bouquets, use with optional black plastic vase liners (below)
- Metal buckets are sold as eaches; order 1 to receive 1 piece
- Plastic liners are sold in packs of 6 only; order 1 to receive 6 pieces

Item No.	Style	Dimensions	Pack
9923411738	Bucket	7" dia x 12" H	1
9923416431	Liner	7" dia x 10" H	6

Additional sizes and colors can be made to order (minimum quantities apply).

Portable Watering System

- A convenient and efficient system for watering plants or misting produce
- Eliminates buckets and hand pumps, simply fill at any faucet and safely transport pressurized water
- Both units have metal wands for ease in watering hanging plants
- Includes coated nylon trash bag with storage pockets, removable service tray, security lid and double-wall PVC hose
- Aluminum and steel construction with two front swivel casters or ease of maneuvering



Item No.	Capacity	Dimensions	Pack
9925410486	9 gal.	12" Wand	1

Additional wand sizes are available..

Waterboy Portable Watering System

- Water or mist plants and produce with this easy-to-use system
- 18-gallon style cart features 12' hose, deluxe wand with extendo-flex no-drip tip, utility tray, sink-to-hose adapter, and 23 gallon tank which holds 16-18 gallons of usable water
- Steel



Item No.	Capacity	Dimensions	Pack
9925416260	18 gal.	18" W x 31" D x 43" H	1

Additional styles can be made to order (minimum quantities apply).

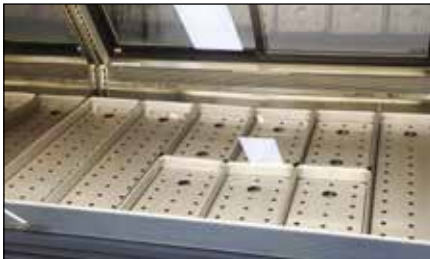

9922818454



9922511521



NSF Stainless Steel Display Pans

In fresh food retail, customers require freshly prepared foods and clean pans and other small ware displays to showcase them.

Stainless Steel Display Pans are the ideal choice for transporting, storing, and displaying food products. Designed for durability and food safety, all components are constructed from rust-proof stainless steel and NSF certified with rounded corners to ensure pans are easy to clean. No sharp corners or crevices for bacteria to hide.

Drain inserts* nest perfectly into each display pan to lift product off the bottom, improving air circulation and keeping foods fresh longer!

With food safety concerns at an all-time high, Stainless Steel Display Pans are a must-have for meat and seafood departments, and also excellent options for deli and bakery foods – cooked or fresh.

- Made with heavy-duty 16 gauge, 304 stainless steel construction
- Large, round corners are easy to clean
- NSF Certified

Item No.	Style	Dimensions	Pack
Pans with inserts			
9922818454	Stainless Steel Meat/Seafood Tray, NSF Certified	8" L x 30" W x 2" H	1
9922818457	Stainless Steel Drain Tray Insert, NSF Certified	8" L x 30" W x 0.5" H	1
9922818455	Stainless Steel Meat/Seafood Tray, NSF Certified	6" L x 15" W x 2" H	1
9922818458	Stainless Steel Drain Tray Insert, NSF Certified	6" L x 15" W x 0.5" H	1
9922818456	Stainless Steel Meat/Seafood Tray, NSF Certified	8" L x 15" W x 2" H	1
9922818459	Stainless Steel Drain Tray Insert, NSF Certified	8" L x 15" W x 0.5" H	1
Pans without inserts			
9800003741	Stainless Steel Pan, NSF Certified	9.75" L x 9.75" W x 3" H	1
9922511520	Stainless Steel Pan, NSF Certified	12" L x 16" W x 2" H	1
9922511521	Stainless Steel Pan, NSF Certified	10" L x 12" W x 1" H	1

Additional sizes and colors can be made to order (minimum quantities apply.)

Stainless Steel Display Pans

Item No.	Style	Dimensions	Pack
9922510301	Drain Holes, 2 Dividers	6" W x 24" W x 1" D	1
9922510302	Drain Holes, 2 Dividers	8" W x 24" W x 1" D	1
9922510307	Drain Holes, 2 Dividers	6" W x 28" W x 1" D	1
9922510308	Drain Holes, 2 Dividers	8" W x 28" W x 1" D	1
9922510309	Drain Holes, No Dividers	16" W x 28" W x 1" D	1
9922510313	Drain Holes, 2 Dividers	6" W x 30" W x 1" D	1
9922510314	Drain Holes, 2 Dividers	8" W x 30" W x 1" D	1
9922510315	Drain Holes, 2 Dividers	16" W x 30" W x 1" D	1
9922510331	No Drain Holes, No Divider	6" W x 15" W x 1" D	1
9922510332	No Drain Holes, 1 Divider	6" W x 24" W x 1" D	1
9922510334	No Drain Holes, 1 Divider	10" W x 24" W x 1" D	1
9922510335	No Drain Holes, 1 Divider	12" W x 24" W x 1" D	1
9922510336	No Drain Holes, 1 Divider	6" W x 12" W x 1" D	1
9922510327	No Drain Holes, 1 Divider	6" W x 30" W x 1" D	1
9922510329	No Drain Holes, 1 Divider	10" W x 30" W x 1" D	1
9922510330	No Drain Holes, 1 Divider	12" W x 30" W x 1" D	1
9922510333	No Drain Holes, 1 Divider	8" W x 24" W x 1" D	1
9922510328	No Drain Holes, 1 Divider	8" W x 30" W x 1" D	1
9922510401	No Drain Holes, 1 Divider	5" W x 30" W x 1" D	1
9922510402	No Drain Holes, 1 Divider	5" W x 24" W x 1" D	1
9922510202	No Drain Holes, No Divider	10" W x 12" W x 2" D	1
9922510203	No Drain Holes, No Divider	20" W x 12" W x 2" D	1
9922510212	Insert for 2" D Pans	10" W x 12" W x .75" D	1
9922510213	Insert for 2" D Pans	20" W x 12" W x .75" D	1
9922510337	Dividers for 1" D Pans with Drain Holes	Fits 6" W	1
9922510338	Dividers for 1" D Pans with Drain Holes	Fits 8" W	1
9922510339	Dividers for 1" D Pans w/o Drain Holes	Fits 6" W	1
9922510340	Dividers for 1" D Pans w/o Drain Holes	Fits 8" W	1
9922510341	Dividers for 1" D Pans w/o Drain Holes	Fits 10" W	1
9922510342	Dividers for 1" D Pans w/o Drain Holes	Fits 12" W	1
9920710020	Clip-On Sign Holder	Fits 1" & 2" D Pans	1
9920710024	Wrap Sign Holder	Fits 2" D Pans	1



Squound™ Stainless Steel Bowls

- Cool square/round shape in striking stainless makes for an eye-catching display
- Available in three sizes to create a set
- Dishwasher safe
- Food safe, can be used in hot and cold cases
- Stainless steel



Item No.	Dimensions	Capacity	Pack
9922110575	7" dia x 2.125" H	1.25 qt	1
9922110576	9" dia x 2.75" H	2 qt	1
9922110577	11" dia x 3" H	4 qt	1



Metallamine™ Display Pans

- Innovative, cutting-edge design gives this line of display pans the appearance of stainless steel with the lightness and durability of melamine
- Affordable solution for cold deli and prepared food cases when stainless steel is not the desired option
- Lighter than stainless steel; easier to handle with product
- Design and material are NSF compliant and made for direct food contact
- Integrated rubber feet
- No sharp edges
- Pans nest together for convenient storage
- For use in cold cases only
- Lower cost than stainless steel
- Easy to clean; hand washing recommended

Item No.	Dimensions	Pack
9922510040	6" W x 12" L x 2" D	1
9922510041	6" W x 15" L x 2" D	1
9922510042	6" W x 20" L x 2" D	1
9922510044	10" W x 10" L x 2" D	1
9922510046	10" W x 12" L x 2" D	1
9922510045	12" W x 20" L x 2" D	1
9922510043	10" W x 12" L x 3" D	1

Slate Melamine Bowls and Platters

- Heavy-weight melamine looks like real slate for an impressive display
- Use as an accent piece or for a specialty set
- Available in bowls and flat platters
- Dishwasher safe; not recommended for microwave use
- Durability of break-resistant melamine



Item No.	Style	Dimensions	Capacity	Pack
9922818435	Square Bowl	5" W x 5" L x 2.875" H	23 oz	1
9922818436	Square Bowl	7" W x 7" L x 3.375" H	1.5 qt	1
9922818437	Square Bowl	9.5" W x 9.5" L x 4" H	3.3 qt	1
9922818438	Square Bowl	12" W x 12" L x 4.5" H	6.5 qt	1

Crescent Melamine Display Bowls – Dalebrook®

- Crescent shape provides unique food display
- Clear polycarbonate dummy insert is 1" D; fits 11" W x 12" L bowls
- Melamine plastic is lightweight and durable



Item No.	Style	Dimensions	Finish	Capacity	Pack
9922119974	Bowl	11" W x 12" L x 2.5" H	Black	2.6 qt	1

Octagonal Bowl

- Octagonal bowl maximizes case space
- Black ABS plastic is virtually unbreakable



Item No.	Style	Dimensions	Finish	Capacity	Pack
9922615192	Bowl	12" L x 10" W x 2" H	Black	2.75 qt	1

Additional sizes and colors can be made to order (minimum quantities apply.)



Melamine Reversible Square Display Bowl



- Square display bowl looks great in case and is reversible
- Helps manage inventory and reduce shrink with 1.75” depth on one side and 1” depth on the other side
- Black high-gloss finish on high-quality melamine
- NSF Certified

Item No.	Dimensions	Finish	Capacity	Pack
9922118535	11.25” W x 11.75” L x 3” H	Black	2.75 qt or 1.6 qt	1



Square Melamine Bowl

- High-gloss square bowl maximizes case space
- Lightweight and durable
- Non-slip feet for secure display
- Black or white melamine

Item No.	Dimensions	Finish	Capacity	Pack
9922110310	12.5” W x 12.5” L x 4” H	Black	4.5 qt	1
9922110318	10” W x 10” L x 2.5” H	Black		1

Dummies available (minimum quantities apply.)



Melamine Baker

- Baker is attractive and durable
- Non-slip feet for secure display
- Black high-gloss finish melamine

Item No.	Dimensions	Finish	Capacity	Pack
With Feet				
9922619605	9” W x 12” L x 2.5” H	Black	2.5 qt	1
Without Feet				
9922619600	9” W x 12” L x 2.5” H	Black	2.5 qt	1

Additional colors can be made to order (minimum quantities apply.)

Melamine Deep Display Bowls

- Deep bowls are ideal for high-volume items such as popular salads and olives
- Available with feet for non-skid use
- Black high-gloss finish
- Clear polycarbonate dummy insert is available for 9.5” and 11” diameter bowls
- Stain- and chip-resistant melamine
- Bowls are NSF Certified



Item No.	Style	Dimensions	Finish	Capacity	Pack
992211674	Bowl w/ Feet	9.5” dia x 4” H	Black	2.75 qt	1
9922110319	Dummy for 9.5” dia	9.5” dia x 2” H	Black	1.4 qt	1
9922116565	Bowl w/ Feet	11” dia x 4” H	Black	4 qt	1
9922116932	Dummy for 11” dia	11” dia x 2” H	Clear	2 qt	1

Additional colors can be made to order (minimum quantities apply.)

Melamine Round Display Bowls

- Round display bowls can be used with other melamine to create customized case sets
- Insert dummy is available for 12” diameter bowl; clear plastic
- High-gloss melamine is durable and attractive
- Bowls are NSF Certified



Item No.	Style	Dimensions	Finish	Capacity	Pack
992211643	Bowl	11” dia x 2.5” H	Black	2.8 qt	1
9922114136	Bowl	12” dia x 2.5” H	Black	3 qt	1
9922114137	Bowl	12” dia x 2.5” H	White	3 qt	1

Additional colors can be made to order (minimum quantities apply.)



Oval Platters



- Sleek, high-gloss oval platters are ideal for salads, entrées or meat displays
- Made of durable high-density melamine
- NSF Certified

Item No.	Dimensions	Finish	Capacity	Pack
With Feet				
9922612655	12" W x 16" L x 2" H	Black	2.9 qt	1
Without Feet				
9922612704	9" W x 12" L	Black	n/a	1

Additional colors can be made to order (minimum quantities apply.)



Melamine Oval Display Platters



- Sleek, high-gloss oval platters are ideal for salads, entrées or meat displays
- Looks like ceramic but without the weight
- Chip-resistant, durable high-density melamine
- Insert dummy is available; clear plastic
- Platters are NSF Certified

Item No.	Style	Dimensions	Finish	Capacity	Pack
9922612827	Platter	17" W x 13" L x 1" H	Black	n/a	1

Additional colors can be made to order (minimum quantities apply.)



Rectangular Melamine Platter

- Angled sides for merchandising product flat or mounded
- High-gloss finish is attractive and durable
- Rubber non-slip feet for secure display
- White melamine

Item No.	Dimensions	Finish	Pack
9922613963	7.30" W x 11" L x .40" H	White	1

Additional colors can be made to order (minimum quantities apply.)



Melamine Rectangular Display Platters



- Rectangular display platter has classic styling with raised sides
- High-gloss finish; melamine plastic is long-lasting
- NSF Certified

Item No.	Dimensions	Finish	Pack
9922619967	9.75" W x 13" L x 1.5" H	Black	1
9922610896	13.25" W x 22.25" L x 1.5" H	Black	1

Additional colors can be made to order (minimum quantities apply.)

Melamine Rectangular Display Tray

- Rectangular tray with angled sides allows for merchandising flat or mounded product
- Available in a variety of sizes to meet merchandising needs
- Heavy-weight melamine has the look of china with the durability of plastic
- All trays feature non-slip feet
- Black or white melamine



Item No.	Dimensions	Finish	Pack
9922610318	8" W x 14" L x 1 1/4" H	Black	1
9922610319	8" W x 14" L x 1 1/4" H	White	1
9922610312	8" W x 15" L x 1.5" H	Black	1
9922619831	8.75" W x 17.5" L x 1.75" H	Black	1
9922614157	8.75" W x 17.5" L x 1.75" H	White	1
9922610314	10" W x 12" L x 1.5" H	Black	1

Additional colors can be made to order (minimum quantities apply.)

Melamine Rectangular Platters

- Rectangular platters look like china, but are break-resistant melamine
- High-gloss finish melamine plastic is extremely durable and long-lasting
- NSF Certified



Item No.	Dimensions	Finish	Pack
9922617748	9.5" W x 17" L x 1.25" H	Black	1

Additional colors can be made to order (minimum quantities apply.)

Black Plastic Display Trays

- Attractively display baked goods and other merchandise with trays
- Durable ABS plastic will not chip

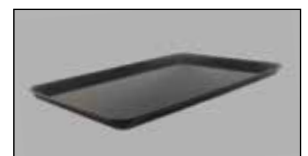
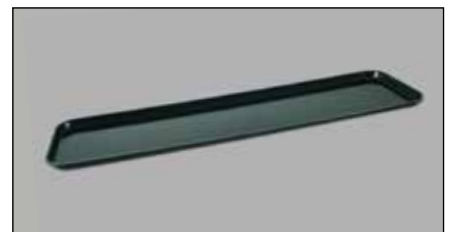

Item No.	Dimensions	Finish	Pack
9922811375	9" W x 26" L x 1" H	Black	1
9922810472	18" W x 26" L x 1" H	Black	1

Additional sizes and colors can be made to order (minimum quantities apply.)



Fiberglass Reinforced Display Trays

- Fiberglass Reinforced Display Trays
- Trays stocked in black and white; additional colors can be made to order
- Rims are reinforced for years of service
- Black trays add sales appeal to your food display
- Durable fiberglass trays have no sharp edges and will not oxidize

Item No.	Dimensions	Finish	Pack
9922810908	6" W x 30" L x .75" H	Black	1
9922818799	6" W x 30" L x 2" H	Black	1
9922812405	8" W x 30" L x .75" H	Black	1
9922817092	8" W x 30" L x 2" H	Black	1
9922811166	9" W x 18" L x 1" H	Black	1
9922815044	9" W x 26" L x .75" H	Black	1
9922819381	10" W x 30" L x .75" H	Black	1
9922817960	15" W x 20" L x 1" H	Black	1
9922817140	18" W x 26" L x 1" H	Black	1

Additional sizes and colors can be made to order (minimum quantities apply.)



Meat Display Trays

- Use black trays and pans to create a dynamic presentation of meats
- Many sizes available to fit on standard size step risers and allow for plan-o-grammed case sets
- Black, unbreakable ABS plastic
- 30" L trays for traditional cases
- 23.75" L trays for over/under cases
- 15" L trays fit in 30" L trays to create two separate bins

Item No.	Dimensions	Finish	Pack
9922817684	6" W x 30" L x .75" H	Black	1
9922816407	6" W x 30" L x 2" H	Black	1
9922810444	6.5" W x 30" L x .75" H	Black	1
9922814342	8" W x 30" L x .75" H	Black	1
9922816658	8" W x 30" L x 2" H	Black	1
9922810281	10" W x 30" L x .75" H	Black	1
9922817348	10" W x 30" L x 2" H	Black	1
9922818789	6" W x 23.75" L x 1" H	Black	1
9922818425	6" W x 23.75" L x 2" H	Black	1
9922811772	8" W x 23.75" L x 1" H	Black	1
9922813819	8" W x 23.75" L x 2" H	Black	1
9922819343	10" W x 23.75" L x 1" H	Black	1
9922810241	10" W x 23.75" L x 2" H	Black	1
9922817317	6.5" W x 15" L x .75" H	Black	1
9922818206	8.5" W x 15" L x .75" H	Black	1
9922618170	12" W x 30" L x .75" D	Black	1

Additional sizes and colors can be made to order (minimum quantities apply.)

Shallow Tray

- Shallow tray attractively merchandises baked goods and other smaller food items
- Works well in deli for displaying specialty breads and rolls
- Clear acrylic



Item No.	Dimensions	Finish	Pack
9923913133	9" W x 18" L x 1" H	Clear	1

Additional sizes and colors can be made to order (minimum quantities apply.)

Sani-Platters

- Super high-impact polystyrene platters for use in every department
- Seamless construction of sanitary polystyrene resists the corrosive attacks of food and meat acids, strong detergents and temperature changes
- Black or white polystyrene

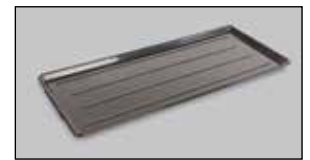

Item No.	Dimensions	Finish	Pack
9922618614	12" W x 24" L x .75" D	White	1
9922612372	12" W x 30" L x .75" D	White	1
9922618170	12" W x 30" L x .75" D	Black	1

Additional sizes and colors can be made to order (minimum quantities apply.)

Octagonal Display Trays

- Octagonal black trays create a dynamic presentation of fresh or cooked food
- Black ABS plastic



Item No.	Dimensions	Pack
9922619830	8" W x 10" L x 2" H	1
9922615192	10" W x 12" L x 2" H	1

Additional sizes and colors can be made to order (minimum quantities apply.)

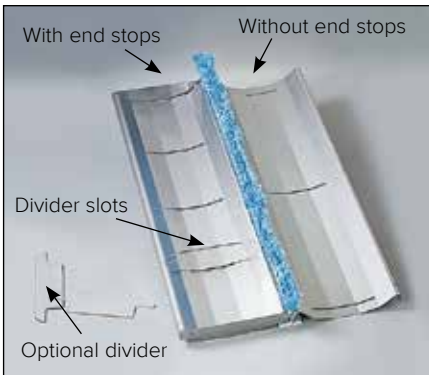

Stainless Steel Reversible Seafood Trays

- Stainless steel seafood trays have a unique curved design and can be turned on either side to create a mound effect for fillets or a trough for shellfish
- Trays can be moved directly from display to freezer, eliminating labor and counter prep time
- FDA approved stainless steel provides maximum cold conduction while reducing shrink
- Drainage holes in trays reduce spoilage
- Slotted trays accommodate optional clear PETG dividers to display more than one item per tray; dividers designed for use on either convex or concave side and are not reversible
- 9922812693 – 1 single divider for use on convex side
- 9922812790 – set of 2 dividers, one for concave, one for convex side
- Trays are available with or without welded end stops
- Shown with divider and blue parsley (see page 531)
- Extremely durable, rust-proof stainless steel construction cleans easily with soap and water

Item No.	Style	Dimensions	Number of Divider Slots	Pack
9922815323	Tray w/o End Stops	6" W x 30" L	5	1
9922811238	Tray w/o End Stops	8.5" W x 30" L	5	1
9922812693	Divider	6" W	n/a	1
9922812790	Divider	8.5" W	n/a	1

Wire Display Baskets and Trays

- Tapered wire baskets and trays are ideal for bulk displays
- Heavy enamel-coated steel with metallic finish in copper or smooth gray
- Clear plastic liners sold as a case in sets of 12; order 1 to receive a pack of 12
- Baskets are sold as eaches, but are packaged 12 per case; order 1 to receive one basket



Item No.	Style	Dimensions	Finish	Pack
9923017030	Basket (ea)	6" W x 18" L x 2" H	Antique Copper	1
9922816401	Basket (ea)	6" W x 18" L x 2" H	Smooth Gray	1
9923010548	Basket (ea)	12" W x 18" L x 2" H	Antique Copper	1
9922810918	Basket (ea)	12" W x 18" L x 2" H	Smooth Gray	1

Synthetic Baskets

- Long-life baskets can be washed for improved sanitation and re-used for cost savings
- Available in multiple styles and sizes
- Brown synthetic wicker



Item No.	Style	Dimensions	Pack
9923010055	Non-Tapered	11" W x 8" L x 3" H	1
9923011839	Tapered	15" W x 16" L x 4"- 9" H	1
9923019347	Tapered	16" W x 16" L x 3"- 5" H	1

Additional sizes and colors can be made to order (minimum quantities apply.)



Assorted Rattan Baskets

- Baskets can be used for décor or display to create a European market look
- Round and Oval baskets available in multiple sizes
- Rattan

Item No.	Style	Dimensions	Finish	Pack
9923010724	Oval Basket w/ Handles	19" x 16" x 13.5"	Natural	1
9923014838	Round Basket w/ Handles	21.5" dia x 12.5" H	Natural	1
9923012633	Oval Basket w/ Handles	18" x 9" x 2.5"	Natural	1

Additional sizes can be made to order (minimum quantities apply.)



Rattan Baskets and Liners

- Rattan Baskets are the ideal way to merchandise fresh product
- Makes a dramatic display and a natural “earthy” presentation

Item No.	Style	Dimensions	Finish	Pack
9923019598	Basket w/ Handles	13" W x 17" L x 3" H	Natural	1
9923017798	Basket w/ Handles	18" W x 24" L x 4" H	Natural	1
9923019597	Basket w/o Handles	13" W x 17" L x 3" H	Natural	1
9923017799	Basket w/o Handles	18" W x 24" L x 5" H	Natural	1
9923019601	Basket w/o Handles	13" W x 17" L x 3" H	Tea-Stained	1
9923019602	Basket w/o Handles	18" W x 24" L x 5" H	Tea-Stained	1

Additional sizes can be made to order (minimum quantities apply.)

Melamine Buffet Stones

Add dimension and attract attention with beautiful marble stone prints for a natural, upscale presentation.

- Maximizes visual impact in any standard deli case; designed to resemble real broken stone
- Riser system adds varying height to the display
- Thicker construction prevents warping
- Use flat on surface or with available pedestals
- Constructed from heavy-weight .75" thick melamine for a realistic black marble look

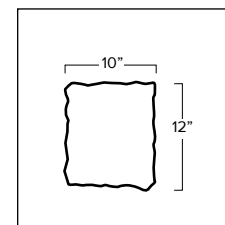

Item No.	Dimensions	Finish	Pack
9921419179	10" W x 12" L	Black Marble	1
9921415260	20" W x 24" L	Black Marble	1

Additional sizes and colors can be made to order (minimum quantities apply)

Non-Skid Pedestals

- Pedestals feature non-skid technology to securely raise display product
- Economical but durable design features rubber coating to provide a non-skid surface
- Stackable to conserve back room storage space when not in use
- Base tapers at the top
- Black metal with rubber coating

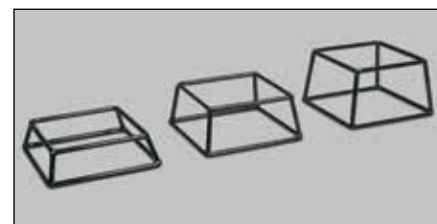

Item No.	Dimensions	Finish	Pack
9921319595	6" W x 7" L x 1" H	Black	1
9921319594	6" W x 7" L x 2" H	Black	1
9921317280	6" W x 7" L x 3" H	Black	1
9921317505	6" W x 7" L x 4" H	Black	1
9921310310	6" W x 7" L x 5.5" H	Black	1
9921310311	6" W x 7" L x 6.5" H	Black	1

Stainless Steel Pedestals

- Stainless steel rounds add strength and versatility to displays
- Available in a variety of sizes for use singly or grouped
- Stainless steel is long-lasting for years of use



Item No.	Dimensions	Pack
9921314155	3" H x 8" dia Top x 6" dia Base	1
9921318240	5" H x 8" dia Top x 6" dia Base	1
9921313941	8" H x 12" dia Top x 8" dia Base	1



Regency Scroll Pedestal

- Ornate scrollwork defines these attractive pedestals
- Use to add dimension to your case or highlight certain items
- Pedestals fit a variety of bowls, platters, and trays
- Black steel construction is extremely durable

Item No.	Style	Dimensions	Finish	Pack
9921317445	Pedestal	6" W x 6" L x 2" H	Black	1
9921314187	Pedestal	6" W x 6" L x 3" H	Black	1
9921318614	Pedestal	6" W x 6" L x 4" H	Black	1

Additional sizes available



Wire Pedestal Basket

- Elegantly display baked goods, snack-type foods, and other impulse items
- Durable metal construction for long life
- 12" H x 16" diameter
- Steel wire with smooth gray finish

Item No.	Dimensions	Finish	Pack
9923015303	16" dia x 12" H	Gray	1

Two- and Three-Step Risers

- Step risers in assorted sizes provide better product visibility and case appearance
- Steps have front lip to prevent bowls from sliding and ventilation holes for air flow
- Steps are slightly textured to hide scratches;
- Made of black, durable, break-resistant plastic; one-piece vacuum formed

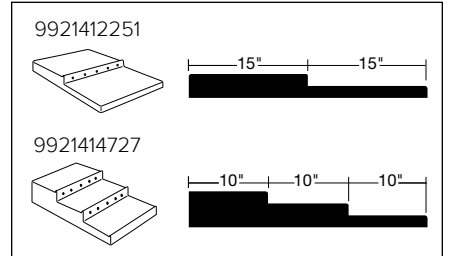

Item No.	Style	Dimensions	Pack
9921412251	Two-step 15/15	24" W x 30" L x 3" H	1
9921418570	Three-step 10/10/10	12" W x 30" L x 4" H	1
9921414727	Three-step 10/10/10	24" W x 30" L x 4" H	1

Additional sizes and colors can be made to order (minimum quantities apply.)

One Piece Riser Combination

- Riser features three steps on the left and two steps on the right
- Slightly textured to enhance visual appeal
- Can be used alone or in combination with the Two-Step or Three-Step Riser
- 5.25" H in back on the three-step side, 3.5" H in back on the two-step side
- Black ABS plastic



Item No.	Dimensions	Finish	Pack
9921410125	24" W x 30" D	Black	1

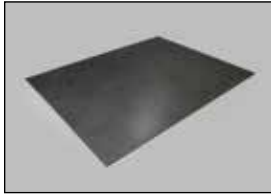
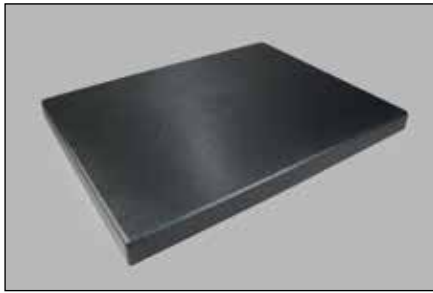

Modular Risers and Flat Bases

- Bases provide a flat surface for landscaping or for zig zag risers
- Available in multiple styles
- Textured finish minimizes appearance of scratches
- Black ABS is very durable

Item No.	Dimensions	Finish	Pack
9921410171	24" W x 30" L x 2" H	Black	1
9921413597	24" W x 30" L x .125" H	Black	1

Additional sizes and colors can be made to order (minimum quantities apply.)



Slant Riser with Adjustable Height Legs

- Present product at an easy viewing angle and enhance visual appeal by adding dimension to displays
- Riser features front lip to secure product on riser
- Legs adjust to change height from 6" to 8.75" in 1" increments
- Black ABS

Item No.	Dimensions	Finish	Pack
9921414644	24" W x 29" L x 6" to 8.75" H	Black	1

Additional sizes and colors can be made to order (minimum quantities apply.)



Slant Risers

- Elevate trays and platters for improved product visibility and to create the illusion of a fuller looking case
- Front lip keeps pans securely displayed on riser; sides and supports are ideal for heavier product and provide added stability
- 9921412735 is 4" H on front end 9921417352 has front lip 3" from bottom of riser to keep pans farther back from case glass
- Made of break-resistant black ABS plastic

Item No.	Style	Dimensions	Pack
9921418239	w/ front lip & sides, w/ supports	24" W x 26" L x 3.5" H	1
9921415231	w/ front lip & w/o sides, w/ supports	24" W x 30" L x 4" H	1
9921417352	w/ front lip & sides, w/ supports	24" W x 30" L x 4" H	1
9921410287	w/ front lip & w/o sides, w/ supports	24" W x 30" L x 7" H	1

Additional sizes and colors can be made to order (minimum quantities apply.)

Stainless Steel Slant Riser

- Use slant riser as a “dummy” under seafood ice displays to reduce ice requirements by 75%, or alone as a riser for seafood trays
- Stainless steel will not rust and conducts colder temperatures for seafood



Item No.	Dimensions	Finish	Pack
9921410808	23" W x 30" L x 4.5" H	Steel	1

Seafood Ice Wedge Set

- Reduce the amount of ice in seafood cases
- Each ice wedge measures 15.5" W x 23" L x 1" H front and 4" H back
- White heavy-duty plastic
- Set of four; order 1 to receive 4 ice wedges



Item No.	Dimensions	Finish	Pack
9921813345	15.5" W x 23" L x 1" H front and 4" H back	White	4



These stylish risers are perfect for showcasing premium products like steaks and filets



Melamine Butcher Block Risers

- Risers have the stylish look of wood butcher block with the economy and durability of melamine
- Available in multiple sizes
- Use two 24" W x 15" L for 30" deep cases
- Hand-washing recommended
- Chip-resistant melamine in wood look

Item No.	Dimensions	Pack
9921418841	15" W x 11" L x 2" H	1
9921410645	24" W x 10" L x 1.25" H	1
9921411016	24" W x 15" L x 2" H	1
9921410647	24" W x 15" L x 2.5" H	1
9921410646	24" W x 20" L x 1.25" H	1



Modular Multi-Color Wood Risers

- Arrange individually or group together to create a step-up effect
- Tops are solid; sides are slotted to allow air to circulate freely
- Two-step riser kit includes base (24" W x 30" L x 2.5" H) and middle step (24" W x 15" L x 2.5" H)
- Richly styled in multi-color real wood with durable urethane finish



Item No.	Style	Dimensions	Pack
9921417981	Kit	24" W x 15" L and 30" L	1
9921411083	Riser	11" W x 15" L x 2.5" H	1
9921410715	Riser	24" W x 15" L x 2.5" H	1
9921412268	Riser	24" W x 30" L x 2.5" H	1



Bulk Meat and Cheese Zig Zag Risers

- Bring bulk meat and cheese into full view without using a lot of inventory
- Risers hold loaves upright and require less product to create a full-looking case
- System helps reduce shrink
- 9921418892: Three-step with open back for storage and solid risers
- 9921419042: Two-step with open back for storage
- Black ABS plastic



Item No.	Style	Dimensions	Pack
9921414351	Three-step/Open and Slotted	24" W x 24" L x 12" H	1
9921418892	Three-step/Open	24" W x 20" L x 14.5" H	1
9921419042	Two-step/Open	24" W x 15.5" L x 16" H	1

Additional sizes and styles can be made to order (minimum quantities apply).



Rolling Merchandiser

Wood Display Fixtures are ideal for packaged bakery items, floral and seasonal displays



Wood Display Fixtures

- Attractive wood display fixtures maximize merchandising space
- Table-top merchandising allows for appealing presentations
- Great for permanent display or cross-merchandising
- Use multiple units to create custom displays
- Display unit anywhere in store for long-term or temporary promotions



Flat Top Tables



Nesting Tables

Call for details. Minimum quantities and lead times may apply. Additional wood variations, sizes and finishes can be made to order.

Interlock™ Cross Merchandising Rack

- Merchandise product in front of display cases
- Low profile will not block view
- Wire product stop keeps product in place
- Kit includes: two 48" L x 14" D shelves, four 18" H posts, two Data Strip® Label Holders, two post clamps, and one wire product stop
- Black-finish steel



Item No.	Dimensions	Finish	Pack
9925510792	48" L x 14" D x 18" H	Black	1

Mobile Two-Tier Wire Dump Bin

- Heavy-duty wire dump bin can be used anywhere for long-term or temporary displays
- Ideal for cross-merchandising promotional items
- Includes two 18" W x 12" D x 10.25" H baskets; inner dimension is 17.25" W x 11.125" D
- Baskets feature three built-in sign channels to hold paper signs: front holds 7" H x 11" W sign and each side holds 3.5" H x 5.5" W signs
- Overall size 20" W x 13" D x 47" H
- 2" diameter caster wheels provide easy mobility
- Includes two locking casters on front and two non-locking casters on back
- Black coated wire



Item No.	Dimensions	Finish	Pack
9923219361	20" W x 13" D x 47" H	Black	1

Spot Basket Merchandiser

- Boost impulse sales with convenient spot merchandising set
- Ideal for highlighting feature items and for stores with limited display space
- Includes one 18" x 15" synthetic wicker basket, one 7" x 11" black sign frame, and one black iron stand



Item No.	Dimensions	Pack
9923017275	18" dia x 15" H	1

Additional styles can be made to order (minimum quantities apply.)



Swivo•Clamp™ Extended Sign Holder 1602

- Display signs above a variety of fixtures
- Universal knuckles allow you to tilt and rotate at the bottom and top
- Clip lined with anti-slip coating
- Plastic spring for misted environments
- Clip grips up to 1.125" thick
- Displays material from .008" to .020" thick
- 2" extender; 6" overall length
- Black plastic with clear sign holder

Item No.	Dimensions	Finish	Pack
9920715452	6" L	Black / Clear	1



Swivo•Clamp™ Extended Wide Sign Holder 1605

- An extra-firm grip sign holder with extender
- Universal knuckles tilt and rotate at bottom and top
- Clip lined with anti-slip coating
- Plastic spring for misted environments
- Fits on fixtures up to 1.125" thick
- Displays materials up to .25" thick
- 1.75" extender; 6.25" overall length
- Black plastic

Item No.	Dimensions	Finish	Pack
9920715453	6.25" L	Black	1



Swivo•Clamp™ Wide Sign Holder 4022

- Perfect when you need a stronger grip on signs
- Universal knuckle tilts material in any direction
- Extra-firm grip sign holder is 3" W
- Clip lined with anti-slip coating
- Plastic spring for misted environments
- Fits on fixtures up to 1.125" thick and displays materials up to .25" thick
- 4" overall length
- Black plastic

Item No.	Dimensions	Finish	Pack
9920715454	4" L	Black	1



Swivo•Clamp™ Sign Holder with Two-Way Swivel

- Perfect for displaying signs on stainless steel or melamine pans, or fixtures throughout the store
- Two-Way Swivel tilts sign to the front or back for the ideal viewing angle
- Extra-firm grip sign holder is 3" W
- Plastic spring for misted environments
- Fits on fixtures up to 1" thick and displays materials up to .25" thick
- 4" overall length; clear plastic
- Packaged 25/bag; sold in full bags only

Item No.	Dimensions	Finish	Pack
2805651002	3" W	Clear	25

Crystal Easel Ticket Holder

- Durable holder with a glass-like appearance
- Easel design adds stability and display flair
- Holds material up to .080" thick
- Clear PVC

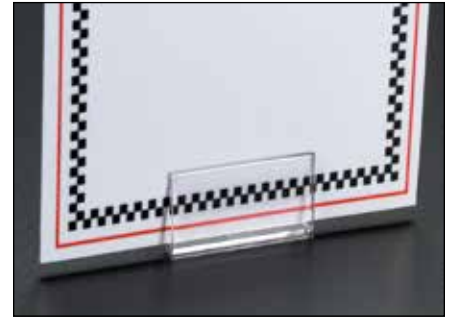

Item No.	Dimensions	Finish	Pack
2161722400	1.25" L x 1" D	Clear	1

Additional lengths can be made to order (minimum quantities apply.)

Weighted Base Flat Sign Holder

- Weighted base keeps sign holder upright
- Snap clip ensures a tight grip on signs
- Rust-proof stainless steel for durability
- Triangular base measures 1.75" W x 1.75" L x 1.75" H
- Stainless steel with black vinyl-coated steel base

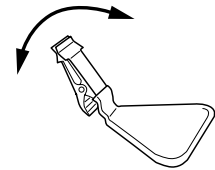

Item No.	Dimensions	Finish	Pack
9920711650	1.75" H	Black	1

Additional colors can be made to order (minimum quantities apply.)

Black Weighted Base European-Style Sign Holders

- Heavy weighted base keeps holders upright
- Resists rusting and corroding in damp environments
- Available with gator clip or clear card holder strip clip
- Black zinc-coated steel



Item No.	Style	Dimensions	Pack
9920710126	Card Holder Strip	3" H	1
9920712071	Card Holder Strip	6" H	1

Additional sizes and styles can be made to order (minimum quantities apply.)



Harp Clip Sign Holder

- European-style “harp” clips add a touch of class to any hot or cold food display
- Heavy weighted base is very stable
- Stainless steel

Item No.	Dimensions	Finish	Pack
9920719670	1.5" H	Silver	1
9920713708	6" H	Silver	1
9920710013	12" H	Silver	1
9920713898	1.5" H	Black	1

Additional sizes can be made to order (minimum quantities apply.)



Black Weighted Base European-Style Sign Holders

- Heavy weighted base keeps holders upright
- Resists rusting and corroding in damp environments
- Gator clip for secure hold
- Black zinc-coated steel

Item No.	Dimensions	Finish	Pack
9920715460	3" H	Black	1
9920714447	6" H	Black	1

Additional sizes and styles can be made to order (minimum quantities apply.)



Spiral Base Card Holders

- Add a fun touch to any display and put a new twist on a traditional look
- Suitable for use in hot cases
- Various-height holders allow you to consistently sign multiple areas
- Split ring top holds tag securely
- Black or chrome powder-coated steel

Item No.	Dimensions	Finish	Pack
9920717691	1.75" H	Black	1
9920716818	5" H	Black	1
9920714252	7" H	Black	1
9920715326	4" H	Chrome	1
9920710456	6" H	Chrome	1

Additional sizes and colors can be made to order (minimum quantities apply.)

Stainless Steel Card Holder

- Ideal for calling attention to specialty items, display ingredient cards, etc.
- Wire ring top holds sign tags securely
- Weighted base measures 2.625" (6.7 cm)
- Stainless steel, deluxe electro-polished finish

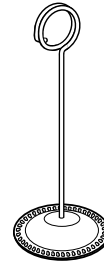

Item No.	Dimensions	Finish	Pack
9920716994	6" H	Silver	1

Additional sizes can be made to order (minimum quantities apply.)

Spiral Cone Card Holder

- Spiral shape adds a unique touch to any display
- Split ring top holds signs securely
- Metal construction is durable and stable
- Black finish metal



Item No.	Dimensions	Finish	Pack
9920710650	3" H	Black	1

Additional sizes and colors can be made to order (minimum quantities apply.)

Mini Chalk Cards

- Write-on cards with contemporary chalk look
- Display with clip style or slotted card holders
- Looks great with the Hammered Aluminum Card Holders
- White Chalk Marker included with each pack
- Available in multiple sizes
- Black wet-erase board
- Sold in packs of 20



Item No.	Dimensions	Finish	Pack
9920710145	3" L x 2" H	Black	20
9920710146	4" L x 3" H	Black	20
9920710147	6" L x 4" H	Black	20

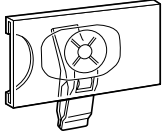

Swivel Clip Sign Holder

- Covered face, side load holder allows signage to remain secure when handled
- Swivel feature allows for limitless attachment points and multiple viewing angles
- Clear acrylic window provides a crystal-clear view of sign
- Clip engineered to minimize stress on consumer goods
- Fits onto materials up to .375" thick
- Holds 1.25" H x 2.5" L signs
- Use with floral buckets and vases
- Clear polycarbonate
- Packaged: 50/bag

Item No.	Dimensions	Finish	Pack
1506217601	1.25" H x 2.5" L	Clear	50

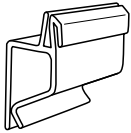

Multi-Purpose Sign Holder

- Holds tag in two positions for high or low profile signing
- Fits most standard bowls or pans
- Tag holder uses friction-fit for a secure grip on paper and vinyl signs
- Black or clear plastic

Item No.	Dimensions	Finish	Pack
9920715972	1.25" L	Black	1
9920715971	1.25" L	Clear	1

Additional sizes and colors can be made to order (minimum quantities apply.)

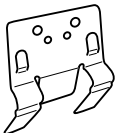

Stainless Steel Pan Clip

- Securely holds signs on bowls, trays, and stainless steel pans
- Stainless steel is ideal for hot food cases

Item No.	Dimensions	Finish	Pack
9920710671	2.375" W x 2.375" H	Silver	1

Stainless Steel Pans and Accessories

- Multi-purpose pans and accessories can be used for freezing, storing, cooking and serving
- Fits standard steam table wells
- Pans feature an anti-jamming design for easy storage
- Wire grates raise food off bottom of pan
- 22 gauge stainless steel with reinforced corners
- Available in a wide range of sizes:
 - Full pan is 12.75" x 20.75" (fits one 12" x 20" opening)
 - Half Long pan is 6.375" x 20 7/8" (two fit one 12" x 20" opening)
 - Half pan is 10.375" x 12.75" (two fit one 12" x 20" opening)
 - Third pan is 6.875" x 12.75" (three fit one 12" x 20" opening)
 - Fourth pan is 6.375" x 10.375" (four fit one 12" x 20" opening)
 - Sixth pan is 6.375" x 6.9375" (six fit one 12" x 20" opening)
 - Ninth pan is 4.25" x 7" (nine fit one 12" x 20" opening)



6" D Pans and Ninth Pan

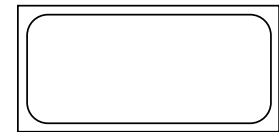

Full Pan

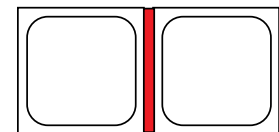

Half Pan

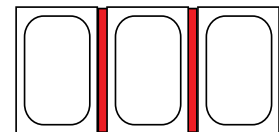

Third Pan

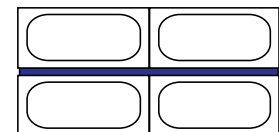

Fourth Pan

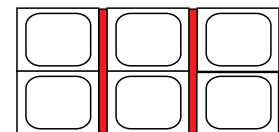

Sixth Pan

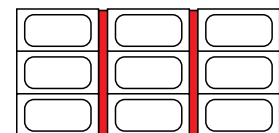

Ninth Pan



20" Adapter Bar



12" Adapter Bar

Item No.	Style	Dimensions	Capacity	Pack
Pans				
9922511510	Full Pan	2.5" D	8.3 qt	1
9922511081	Full Pan	4" D	14.0 qt	1
9922511592	Full Pan	6" D	21.0 qt	1
9922511248	Half Pan	2.5" D	4.3 qt	1
9922516296	Half Pan	4" D	6.7 qt	1
9922511055	Half Pan	6" D	10 qt.	1
9922512245	Half Long Pan	2.5" D	3.9 qt	1
9922519754	Half Long Pan	4" D	6.0 qt	1
9922516383	Third Pan	2.5" D	2.6 qt	1
9922514852	Third Pan	4" D	4.1 qt	1
9922517439	Third Pan	6" D	6.1 qt.	1
9922515238	Fourth Pan	2.5" D	1.8 qt	1
9922515209	Fourth Pan	4" D	3.0 qt	1
9922511333	Fourth Pan	6" D	4.5 qt.	1
9922512191	Sixth Pan	2.5" D	1.4 qt	1
9922516407	Sixth Pan	4" D	1.6 qt	1
9922512018	Ninth Pan	4" D	1.1 qt	1
Covers				
9922511836	Full Cover	n/a	n/a	1
9922510883	Half Cover	n/a	n/a	1
9922511422	Third Cover	n/a	n/a	1
9922211904	Fourth Cover	n/a	n/a	1
9922517698	Sixth Cover	n/a	n/a	1
Wire Grates				
9922518750	Full Wire Grate	10" W x 18" L	n/a	1
9922518133	Half Wire Grate	8" W x 10" L	n/a	1
9922512874	Third Wire Grate	5" W x 10.25" L	n/a	1
Adapter Bars				
9922514210	Adapter Bar	12" L	n/a	1
9922518829	Adapter Bar	20" L	n/a	1

Additional sizes can be made to order (minimum quantities apply.)

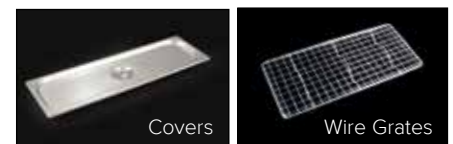

Covers

Wire Grates



Adapter Bars



Hot Food Pans



- Ideal for freezing, cooking and heating in temperatures from -40°F to 375°F
- For use in microwaves, steam tables, ovens and hot holding applications
- Impact- and scratch-resistant
- Stackable and easy to clean
- Commercial dishwasher safe
- Also available in a wide range of sizes (minimum order quantities may apply):
 - Full pan is 12.75" x 20.875" (fits one 12" x 20" opening)
 - Half Long pan is 6.375" x 20 7/8" (two fit one 12" x 20" opening)
 - Half pan is 10.4375" x 12.75" (two fit one 12" x 20" opening)
 - Third pan is 6.9375" x 12.75" (three fit one 12" x 20" opening)
 - Fourth pan is 6.375" x 10.4375" (four fit one 12" x 20" opening)
- Onyx or sandstone plastic
- NSF Certified

Item No.	Style	Dimensions	Capacity	Finish	Pack
9922517554	Full Pan	2.5" D	8.9 qt	Onyx	1
9922512252	Full Pan	4" D	13.7 qt	Onyx	1



Soup/Vegetable Shallow Inserts – Vollrath®

- Shallow inserts create full look during off-peak times
- Shallow 4 quart style fits standard 7 quart 8.5" diameter opening
- Shallow 7 quart style fits standard 11 quart 10.5" diameter opening
- No need to switch templates to smaller sizes
- 18/8 stainless steel

Item No.	Dimensions	Capacity	Pack
9922512876	9.4375" dia x 4.875" D	4.0 qt	1
9922514955	11.3175" dia x 5.6275" D	7.0 qt	1

Soup/Vegetable Inserts and Covers

- Attractive soup and vegetable inserts have a mirror-polish finish exterior and a satin finish interior
- Inserts nest together for compact storage
- Covers available; larger sizes are hinged for easy access
- All covers feature a utensil notch
- 18/8 stainless steel



Item No.	Style	Dimensions	Capacity	Pack
Pots				
9922513148	Standard Pot	7" dia x 8.25" D	4.0 qt	1
9922516337	Standard Pot	9.5" dia x 8.25" D	7.25 qt	1
9922517180	Standard Pot	11.25" dia x 8.25" D	11.0 qt	1
Covers				
9922511719	Embedded loop handle	7" dia	n/a	1
9922510259	Black knob handle, hinged	9.5" dia	n/a	1
9922219974	Raised loop handle, hinged	9.75" dia	n/a	1
9922217850	Raised loop handle, inset door	11.75" dia	n/a	1

Stainless Steel Ergonomic Handle Ladle

- Short handle allows for use under low profile breath guards
- Heat-resistant black ergonomic handle for comfortable use
- Oval shape makes pouring easier
- Stainless steel



Item No.	Dimensions	Capacity	Pack
9922913588	12.80" L	4 oz	1

One-Piece Kool-Touch® Utility Tongs – Vollrath®

- Scalloped edges are ideal for almost any area of the kitchen
- Heat resistant to 180°F (82.2°C)
- No pinch, easy to handle design
- Unique springless design eliminates bacteria-prone food traps
- 20 gauge stainless steel



Item No.	Dimensions	Pack
9922913416	9.5" L	1
9922913095	12" L	1

Additional sizes and styles can be made to order (minimum quantities apply.)



Kool-Touch® Insulated Serving Spoons – Vollrath®

- Serving spoons feature attractive black Kool-Touch® coating
- Coating insulates to provide a cool grip
- Heat resistant to 180°F (82.2°C)
- Stainless steel with black coated handle

Item No.	Style	Dimensions	Pack
9922917543	Slotted	12" L	1
9922915487	Solid	11.625" L	1



High Heat Utensils – Carlisle®

- High heat polysulfone utensils can be used on high temperature surfaces like steam tables without melting or transferring heat
- Withstand temperatures for -40° to 375°F
- One-piece, break-resistant plastic lowers your replacement cost
- Notched handle rests on edge of pan; dishwasher safe
- Will not scratch non-stick coated cookware
- Black polysulfone

Item No.	Style	Dimensions	Pack
9922915003	Perforated Spoon	13" L	1
9922918730	Solid Spoon	13" L	1

Additional sizes and styles can be made to order (minimum quantities apply.)



Heat Resistant Utensils



- Attractive spoons and tongs are suitable for use in hot bars and self-serve buffets
- Handles contain insulated nylon coating to provide a cool grip up to 475°F (246°C)
- Spoons feature integrated loop for easy hanging and storing
- Tongs are spring free; one-piece construction prevents collection of food
- 18/8 heavy-duty stainless steel construction resists corrosion
- NSF Certified

Item No.	Style	Dimensions	Pack
9922913097	Tongs	12" L	1
9922917542	Slotted Spoon	12" L	1

Additional sizes and styles can be made to order (minimum quantities apply.)

Cold Food Pans and Covers



- Ideal for storage, transportation, serving and salad bar
- Stackable and easy to clean
- Not recommended for steam table use
- Also available in a wide range of sizes (minimum order quantities may apply):
 - Full Pan is 12.75" x 20.875" (fits one 12" x 20" opening)
 - Half Pan is 10.4375" x 12.75" (two fit one 12" x 20" opening)
 - Half Long Pan is 6.375" x 20.875" (two fit one 12" x 20" opening)
 - Third Pan is 6.9375" x 12.75" (three fit one 12" x 20" opening)
 - Fourth Pan is 6.375" x 10.4375" (four fit one 12" x 20" opening)
 - Sixth Pan is 6.375" x 6.9375" (six fit one 12" x 20" opening)
- Highly break-resistant black or clear polycarbonate plastic
- NSF Certified



Item No.	Style	Dimensions	Capacity	Finish	Pack
Pans and Trays					
9922510603	Full Pan	4" D	12.3 qt	Clear	1
9922510629	Full Pan	6" D	20.6 qt	Clear	1
9922510604	Half Pan	2.5" D	3.0 qt	Black	1
9922510606	Half Pan	4" D	5.3 qt	Black	1
9922510607	Half Pan	4" D	5.3 qt	Clear	1
9922510594	Half Long Pan	2.5" D	3.0 qt	Black	1
9922510608	Third Pan	2.5" D	2.4 qt	Black	1
9922510610	Third Pan	4" D	3.9 qt	Black	1
9922510611	Third Pan	4" D	3.9 qt	Clear	1
9922510612	Fourth Pan	2.5" D	1.6 qt	Black	1
Covers					
9922510620	Full Cover	12.75" W x 20" L	n/a	Clear	1
9922510621	Half Cover	10.4375" W x 12.75" L	n/a	Clear	1
9922510598	Half Long Cover	6.375" W x 20.875" L	n/a	Clear	1
9922510622	Third Cover	6.3125" W x 12.75" L	n/a	Clear	1
9922510623	Fourth Cover	6.375" W x 1.375" L	n/a	Clear	1
9922510624	Sixth Cover	6.375" W x 6.9375" L	n/a	Clear	1

Additional sizes and colors can be made to order (minimum quantities apply.)



Supreme™ Crocks – Carlisle®

- 1.5” rim makes it easy to remove from food bar template
- See-thru, snap-on lids included
- Made of durable black SAN plastic to resist scuffs and food stains

Item No.	Dimensions	Capacity	Pack
9922318067	5” dia x 5.25” H	1.2 qt	1

Additional colors and sizes can be made to order (minimum quantities apply.)



Store ‘n Pour® Containers – Carlisle®

- 13” H 1-quart container stores and pours salad dressings
- Two-piece spout and neck design for easy cleaning
- High-density, break-resistant polyethylene

Item No.	Style	Finish	Pack
9922117932	Container	Clear	1



Pewter Glo Tongs

- Cast aluminum with pewter glo finish is durable yet beautiful
- Scissor-type tongs are easy to use
- Metal

Item No.	Dimensions	Finish	Pack
9922913295	10” L	Metal	1



Tongs

- Choose from two styles: Salad has one flat edge and one serrated edge; Utility has scalloped edges
- Durable, black polycarbonate plastic

Item No.	Style	Dimensions	Pack
9922919764	Salad	6” L	1
9922915646	Salad	9” L	1
9922914292	Utility	6” L	1
9922911411	Utility	9” L	1
9922912008	Utility	12” L	1

Additional sizes and styles can be made to order (minimum quantities apply.)



Turn-O-Matic® Take-A-Number System

- Let customers browse without losing their place in line 9925318070 includes: wireless system display, 2 remotes, and ticket dispenser with sign
- 9925310998 includes: red ticket dispenser with “Take A Number” sign and counter stand, 12-volt transformer wire and hardware, LED number system
- Wireless tickets sold separately: 4,000 tickets per roll; 24 rolls per case
- Hardwire tickets sold separately: 3,000 tickets per roll; 15 rolls per case (additional ticket colors are made to order)
- Can also order replacement ticket dispenser, floor stand, and English
- “Please Take A Number” sign separately
- Optional floor stand also available



Item No.	Style	Pack
9925318070	Wireless System – T-90	1
9925315212	Tickets-Wireless System – T-90	1
9925310998	Hardwire System – T-80	1
9925315413	Tickets for Hardwire System – T-80	1 Case
9925211573	Replacement Ticket Dispenser for Hardwire System – T-80	1
9925318641	Floor Stand Only	1
9920816708	“Take A Number” Sign	1

Stackable Organizer Bins

- Keep condiments, flatware, and napkins neatly organized and ready to dispense
- Bins may be used individually stacked together, or arranged on poly racks
- Available in multiple bin styles
- Black molded plastic



Item No.	Style	Dimensions	Pack
9924212273	12 Bins	25.125" L x 21.375" D x 14.25" H	1
9924216572	9 Bins	20.125" L x 21.375" D x 14.25" H	1
9924218366	6 Bins	20.125" L x 17.25" D x 9.25" H	1

Additional sizes and colors can be made to order (minimum quantities apply.)



Condiment Organizer-Angled Eight Bin

- Customers can easily access eight angled bins: four large and four small
- Larger rectangular bins are perfect for utensils, coffee stirrers, etc.
- Smaller square bins are ideal for salt and pepper packets, ketchup packets, or coffee creamers
- Black plastic

Item No.	Dimensions	Finish	Pack
9924219963	23" L x 9" D x 4" H	Black	1

Additional colors can be made to order (minimum quantities apply.)



Cup and Lid Organizer

- Keeps deli cups and lids organized and easy to access
- Open wire construction prevents debris from collecting in bottom
- Easily removed for refilling or cleaning
- Four compartments hold 8 oz, 16 oz, and 32 oz cups and 4.5" diameter lids
- Sits on counter or can be mounted on wall (hardware included)
- White coated wire

Item No.	Dimensions	Finish	Pack
9925213037	20.5" L x 5" D x 16" H	White	1



Shakers

- Keep spices and other condiments readily available with 10 oz shakers
- Dishwasher safe and unaffected by food acids
- Available with Cheese Lid for course grinds or Salt and Pepper Lid for fine grinds
- Made of unbreakable clear polycarbonate plastic

Item No.	Style	Color	Capacity	Pack
9922918082	Cheese Lid	Yellow Lid	10 oz	1
9922912968	Salt and Pepper Lid	Beige Lid	10 oz	1

Additional styles can be made to order (minimum quantities apply.)

Neatly organize heavier pegged products like meat and cheese



Mega Bar

Get more out of your display space with the new Mega Bar Peg Display System. The Mega Bar is a strong, durable display system that allows for cleaner, more effective product facings while being adaptable to various display applications. The Mega Bar will handle heavy loads as it utilizes the strength of the gondola uprights. Its steel tube construction increases weight bearing capacity as well, which increases product pack-out!



Slotted Bracket



Clamp Bracket

Item No.	Ref. No.	Dimensions	Finish	Pack
Mega Bar with Slotted Bracket				
7160414255	R-80-0133-002	36" Bar w/ slotted brackets	Chromate	4
7163006366	R-80-0624-002	48" Bar w/ slotted brackets	Chromate	4
Mega Bar with Clamp Bracket				
7165590811	R-80-0072-000	30" Bar w/ clamp brackets	Chromate	4
7166289968	R-80-0070-000	48" Bar w/ clamp brackets	Chromate	4
7155675628	RAAB-CB-003	Replacement End Clamps	Zinc	1

Mega Bar



Mega Bar Stem Hooks



.281 diameter wire for strength and stability.

Mega Bar Scanning Hooks

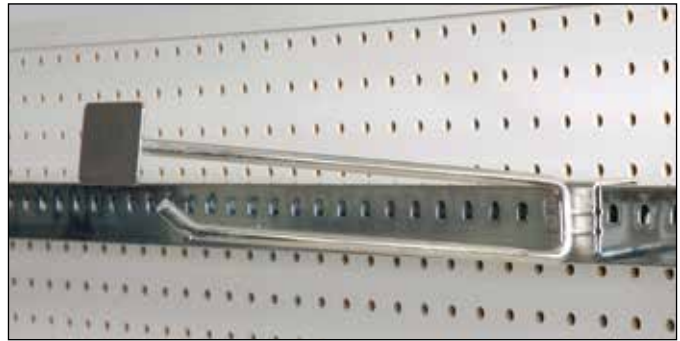

Over-bar attachment. Welded 2" label plate.

Item No.	Ref. No.	Dimensions	Finish	Pack
Mega Bar Stem Hooks				
7162585557	R-80-0071-004	8" single stem hook	Chromate	24
7168742517	R-80-0071-003	10" single stem hook	Chromate	24
7165807146	R-80-0071-001	12" single stem hook	Chromate	24
7166532453	R-80-0071-002	15" single stem hook	Chromate	24
7256132218	-	18" single stem hook	Chrome	1
Mega Bar Scanning Hooks				
7160984951	RRBS-6-P2-C	6" Scan Hook, .281 Dia.	Chromate	100
7164798169	RRBS-8-P2-C	8" Scan Hook, .281 Dia.	Chromate	100
7169425305	RRBS-10-P2-C	10" Scan Hook, .281 Dia.	Chromate	50
7161699586	RRBS-12-P2-C	12" Scan Hook, .281 Dia.	Chromate	50
7166368835	RRBS-14-P2-C	14" Scan Hook, .281 Dia.	Chromate	50
7166973445	RRBS-16-P2-C	16" Scan Hook, .281 Dia.	Chromate	50

Mega Bar Price Channels

- Unique back design provides secure fit in B-Flute corrugated.
- Sizes 2” - 6” available in ABS, 6” and 8” in glass-filled nylon.
- Fits .125” B-Flute Corrugated Displays.

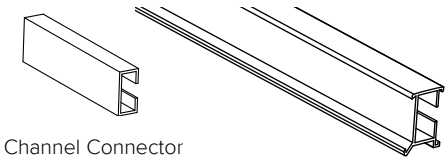
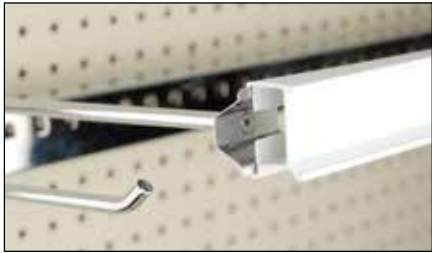

Channel Connector

Item No.	Ref. No.	Dimensions	Finish	Pack
7168867112	RAAB-ID-003	30” price channel	White	4
7165120359	RAAB-ID-002	36” price channel	White	4
7162431968	RAAB-ID-001	48” price channel	White	4
7162340869	RAAB-ID-004	Price channel connector	White	4

Mega Bar Inset Channel Hanger

- Inset hanger holds the channel directly above the stem hooks.
- Features a spring clip for mounting price channel.
- .281 diameter wire for added strength and stability.

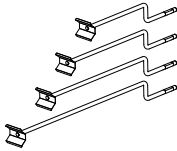

Item No.	Ref. No.	Dimensions	Finish	Pack
7161192136	RAAB-ID-005	8” inset hanger	Chromate	12
7163810581	RAAB-ID-006	10” inset hanger	Chromate	12
7168068016	RAAB-ID-008	15” inset hanger	Chromate	12

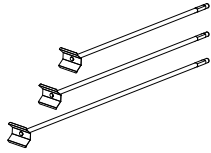

Mega Bar Straight Channel Hanger

- Straight hanger holds the channel directly out in front of the stem hooks.
- Features a spring clip for mounting price channel.
- .281 diameter wire for added strength and stability.

Item No.	Ref. No.	Dimensions	Finish	Pack
7168881061	RAAB-ID-014	15" straight hanger	Chromate	12

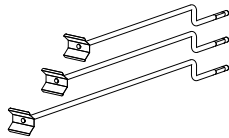

Mega Bar Offset Channel Hanger

- Offset hanger holds the channel both above and in front of the stem hooks.
- Features a spring clip for mounting price channel.
- .281 diameter wire for added strength and stability.

Item No.	Ref. No.	Dimensions	Finish	Pack
7166410760	RAAB-ID-009	10" offset hanger	Chromate	12
7165580489	RAAB-ID-010	12" offset hanger	Chromate	12
7162431621	RAAB-ID-011	15" offset hanger	Chromate	12

Peg Bar Baffle System

- System directs air flow over pegged meats and perishable product for reduced temperatures
- Eliminates case hot spots typically associated with peg bar systems
- Channel molding has a flexible hinge for easy shopping and restocking
- 1.25" H front channel keeps price tags straight and positioned properly
- Clear baffle allows light to shine through
- Universal to most major peg bar systems
- Includes three universal peg bar clips for mounting
- Comes with one splicer to align baffles in a continuous run



Item No.	Dimensions	Finish	Pack
9923218018	15" D x 36" L	Clear	1
9923218017	15" D x 48" L	Clear	1

Peg Hook Label Holder

- Unique two-part merchandiser holds price label in front of hook for easy visibility
- White plastic saddle snaps firmly on hook without removing hook or merchandise
- Clear pricer strip lays straight, adjusts to varying peg hook lengths
- Clear 1.25" H x 3" L pocket allows use with non-adhesive and adhesive labels
- Sold in packs of 50 only; order 1 to receive 50 strips or saddles

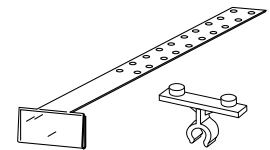

Item No.	Style	Dimensions	Finish	Pack
9920812687	Pricer Strip	14" L	Clear	50
9920813841	Pricer Strip	17" L	Clear	50
9920719282	Saddle	n/a	White	50

4-Pocket Package Rack

- Rack displays packaged product in upright position while keeping product organized in straight rows
- Maximizes visibility of product
- Features four pockets for packaged goods
- Black vinyl coated wire



Item No.	Dimensions	Finish	Pack
9925516540	5" W x 10" D	Black	1

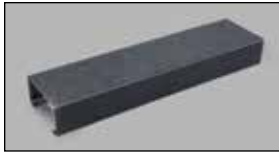

Inventory Blockers

- Use in case wells or on shelves to keep product within easy customer reach
- Reduce inventory on shelves while maintaining a full look
- Perforated style allows air flow
- Black ABS

Item No.	Dimensions	Finish	Pack
9921518891	6" W x 23" L x 3" H	Black	1
9921519920	6" W x 23" L x 6" H	Black	1
9921512866	6" W x 24" L x 6" H	Black	1
9921512867	6" W x 24" L x 9" H	Black	1

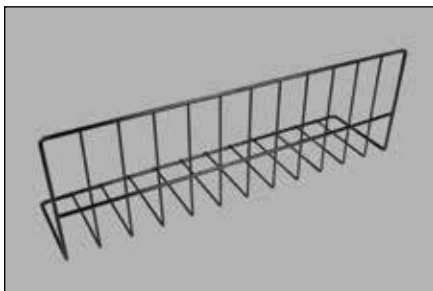

Vinyl-Coated Wire Fencing

- Organize cases and reduce product roll-off with L-shaped fence
- Fence is a different height on each side and can be inverted to accommodate high or low displays
- Available with wires spaced 1" or 2" apart
- Vinyl coated to prevent rusting

Item No.	Dimensions	Finish	Spacing	Pack
9921016825	4" H x 6" H x 24" L	Black	1"	1
9921010496	4" H x 6" H x 24" L	White	1"	1
9921013275	6" H x 8" H x 24" L	Black	2"	1
9921019662	8" H x 12" H x 24" L	Black	2"	1
9921018192	8" H x 12" H x 24" L	White	2"	1
9921017817	8" H x 12" H x 30" L	Black	2"	1
9921019186	8" H x 12" H x 30" L	White	2"	1

Additional sizes and colors can be made to order (minimum quantities apply.)

Clear “L” Dividers

- An alternative to wire fencing, L-shaped dividers can be inverted to accommodate high or low displays
- Use either 4” H side or 6”/ 7” H side as a divider
- Vented styles have a minimum lead time – call for details
- High-impact acrylic or PETG plastic



Item No.	Style	Dimensions	Pack
9921018699	Solid acrylic	4” H x 6” H x 12” L	1
9921017475	Solid acrylic	4” H x 6” H x 24” L	1
9921014664	Vented acrylic	4” H x 6” H x 24” L	1
9921012779	Solid acrylic	4” H x 6” H x 30” L	1
9924017246	Vented acrylic	4” H x 6” H x 30” L	1
9921011004	Solid acrylic	4” H x 6” H x 36” L	1
9921016878	Solid PETG	4” H x 7” H x 36” L	1
9921016493	Solid PETG	4” H x 6” H x 48” L	1
9921018288	Solid PETG	4” H x 7” H x 48” L	1

Additional sizes and colors can be made to order (minimum quantities apply.)

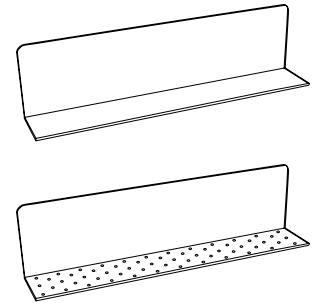

All Purpose “T” Dividers

- Plastic dividers with T-shaped base for stability organize bulk displays
- Dividers are available with angled or straight edges
- Angled style has unique contoured edge to provide finished look to multi-deck cases
- Clear plastic



Item No.	Style	Dimensions	Pack
9921010252	Angled	3” H x 26” L	1
9921017189	Angled	3” H x 16” L	1
9921017186	Angled	3” H x 28” L	1
9921012384	Angled	3” H x 30” L	1
9921010707	Straight	3” H x 30” L	1
9921012087	Straight	3” H x 36” L	1

Additional sizes and colors can be made to order (minimum quantities apply.)



Angled “T” Dividers

- Diamond top angled T-shaped dividers are available in a variety of sizes
- Black plastic



Item No.	Dimensions	Finish	Pack
9921016027	3” H x 10” L	Black	1
9921015230	3” H x 12” L	Black	1
9921016085	3” H x 14” L	Black	1
9921010408	3” H x 16” L	Black	1
9921011818	3” H x 30” L	Black	1

Additional sizes and colors can be made to order (minimum quantities apply.)

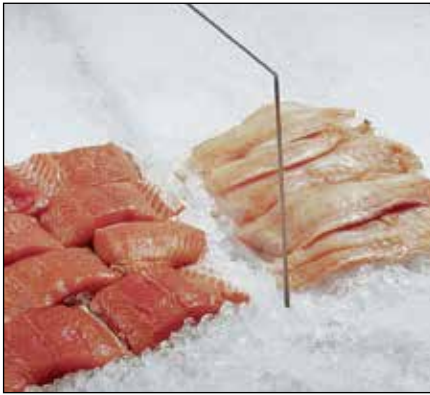

Tapered Case Divider

- Use dividers inside service case to separate cooked from fresh product
- Rigid clear plastic does not obstruct view of product
- Available in straight “L” style or tapered
- L-Divider: 8” H x 30” L, with 4” base
- Tapered Divider: 8” H x 31.25” L, tapers to 6”
- Tapered Divider with Feet: 10.75” H x 21.5” L, tapers to 1.5” H, with 3.5” W feet

Item No.	Style	Dimensions	Finish	Pack
9921018318	Straight L-Divider	8” H x 30” L	Clear	1
9921014673	Tapered Divider	8” H x 31.75” L	Clear	1
9921018222	Tapered Divider with Feet	10.75” H x 21.5” L	Clear	1
9921018223	Tapered Divider w/o Feet	10.5” H x 21.5” L	Clear	1

Additional sizes and colors can be made to order (minimum quantities apply.)



Straight “T” Dividers and Parsley

- T-shaped divider neatly organizes product in cases
- Optional plastic washable parsley runner slides into top channel of “T” divider
- Dividers also available in lengths from 12” to 36”; Parsley also available in Red and Light Blue; call for details

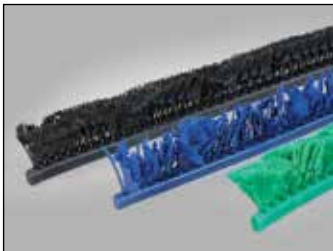

Item No.	Style	Dimensions	Finish	Pack
9921018237	Divider	1” H x 30” L	Black	1
9921016559	Divider	2” H x 30” L	White	1
9921011435	Divider	3” H x 30” L	Black	1
9921014111	Divider	3” H x 30” L	White	1
9921010819	Parsley Runner	1” H x 30” L	Black	1
9921015076	Parsley Runner	1” H x 30” L	Blue	1
9921018093	Parsley Runner	1” H x 30” L	Green	1

Additional sizes and colors can be made to order (minimum quantities apply.)



Angled “T” Dividers With Parsley

- Plastic dividers come completely assembled with 1” H parsley runner
- Angled front is ideal for multi-deck cases
- Available in black divider with black parsley, or white divider with green parsley
- Dividers also available in heights from .75” to 5.5” and lengths from 10” to 30”; Parsley also available in Red and Blue; call for details



Item No.	Dimensions	Finish	Pack
9921011601	28” L x 2” H w/ 1” parsley (30” L x 3” H overall)	Black/Black	1
9921015717	28” L x 1” H w/ 1” parsley (30” L x 2” H overall)	Black/Black	1
9921019828	12” L x 1” H w/ 1” parsley (14” L x 2” H overall)	Black/Black	1
9921013376	14” L x 1” H w/ 1” parsley (16” L x 2” H overall)	Black/Black	1
9921019291	2” H x 18” L w/ 1” parsley (3” H x 19” L overall)	White/Green	1
9921014191	2” H x 14” L w/ 1” parsley (3” H x 15” L overall)	Black/Black	1

Additional sizes and colors can be made to order (minimum quantities apply.)

Motion Mat®



- Low-friction shelf liner is ideal for gravity-feed shelf units
- Helps products glide forward smoothly
- Use in grocery, beverage sections, and freezers or in environments with temperatures below 150°F
- Easy to install, clean, and maintain
- Width and/or depth can be easily cut to ensure ideal fit
- White or black HIPS base with silicone top layer
- NSF Certified and FDA compliant



Item No.	Ref. No.	Dimensions	Finish	Pack
7900000201	RKM-2424K	24" W x 24" D x .083" thick	Black	1
7900000200	RKM-2424W	24" W x 24" D x .083" thick	White	1

Additional sizes and colors can be made to order (minimum quantities apply.)

Extra-Cushioned Non-Skid Case Liner

- Thick liner provides maximum cushion for product such as soft fruits
- Unlike foam, it is colorfast, durable and will not tear or stain
- FDA approved black liner



Item No.	Dimensions	Finish	Pack
9921219540	36" W x 60' L	Black	1

Additional sizes and colors can be made to order (minimum quantities apply.)



Non-Skid Case Liner

- Non-skid case liners anchor product and display accessories to prevent sliding
- Sturdy polyester/vinyl, ideal for refrigerated and non-refrigerated cases
- Colorfast, will not tear
- Available in two thicknesses: thin or medium
- FDA approved black liner

Item No.	Style	Dimensions	Pack
9921217897	Thin	36" W x 60' L	1
9921210328	Thin	48" W x 60' L	1
9921213675	Medium	36" W x 60' L	1
9921212282	Medium	48" W x 60' L	1

Additional sizes and colors can be made to order (minimum quantities apply.)



Wicker Liner

- Washable wicker-look case liner enhances display while allowing air to circulate freely
- Safe material for food contact
- Black liner

Item No.	Dimensions	Finish	Pack
9921212828	36" W x 30' L	Black	1

Additional sizes and colors can be made to order (minimum quantities apply.)



Net Liner

- Most economical way to protect products and cases
- Ideal for displays with significant water/moisture presence
- Prevents product adhesion to bottom of freezer cases
- Washable, reusable, non-absorbent material
- Safe for direct food contact; FDA approved and PVC free

Item No.	Dimensions	Finish	Pack
1500032200	30" W x 74' L	Black	1

Additional sizes and colors can be made to order (minimum quantities apply.)

Floor Model Sampling Center – 35” ADA Compliant

- Full-service sampling center with a shorter 35” high post to meet the requirements of the Americans with Disabilities Act (ADA)
- Black ice/chill tray keeps samples fresh and cold
- Dome has integrated Twist ‘N Lock™ locking feature, to keep lid in place when handled, and an integrated sign holder
- Available with 10” diameter or 15” diameter 3-Piece Sampling Unit with manual-closing door
- Features large rectangular trash receptacle and holder, toothpick dispenser and holder, and napkin holder
- Replacement 3-Piece Sampling Unit, plastic toothpick dispenser and trash receptacle available below
- Black metal stand / Black chill tray / Clear dome



Item No.	Style	Lettering Color	Pack
9923911875	10” dia Sampling Center	Red	1
9923911876	15” dia Sampling Center	Black	1
9923915221	10” dia Replacement 3-Piece Sampling Unit	Red	1
9923911107	15” dia Replacement 3-Piece Sampling Unit	Black	1
9925212132	Replacement Toothpick Dispenser	-	1
9926312282	Replacement Trash Receptacle	-	1

3-Piece Sampling Units

- 3-Piece Sampling Unit ideal for cases and demonstration stations throughout the store
- Chill tray for ice keeps samples fresh longer
- Integrated Twist ‘N Lock™ locking feature to keep lid in place when handled
- 3-Piece Sampling Unit includes dome, tray and black or clear ice/chill tray
- Available with self-closing or manual-closing door
- Clear dome features integrated sign holder
- Durable polycarbonate plastic



Item No.	Style	Finish	Lettering Color	Pack
9923915221	10” Self-Closing	Black Chill Tray	Red	1
9923915222	10” Self-Closing	Clear Chill Tray	Red	1
9923911590	15” Self-Closing	Black Chill Tray	Black	1
9923911107	15” Manual-Closing	Black Chill Tray	Black	1

2-Piece Sampling Units

- Ideal for products that do not require refrigeration
- Features integrated Twist ‘N Lock™ locking feature to keep lid in place when handled
- Dome features manual-closing door and integrated sign holder
- Includes clear dome and black tray
- Durable polycarbonate plastic



Item No.	Dimensions	Finish	Pack
9923912851	10” dia	Black Tray/Clear Dome	1
9923912852	15” dia	Black Tray/Clear Dome	1



ShopRoll Basket

- Lightweight – easy to carry
- Reversible stacking – easy to store
- Dirt evacuation system for easy cleaning
- Rigid steel handle –does NOT sway
- Folding, anti-bacterial handle
- Casters for easy mobility
- Customizable
- Telescopic handle is 15”.



- Custom colors available. Minimum order quantity required.

Item No.	Dimensions	Color	Pack
9923010711	18” W x 16” H x 14” D	Red	1



Pharmacy/Utility Basket

- Baskets for organization and safety in the pharmacy and other areas
- 10.25” L x 6.5” W x 2.5” D
- A variety of sizes and colors are available
- Minimum order quantity required.

Item No.	Ref. No.	Dimensions	Pack
Custom	-	Made To Order	1

Call for details. Minimum quantities may apply. Additional sizes and styles can be made to order.

Tool Bungee

- Bungee cord securely holds tools for easy access
- Adjustable slide tightens or loosens to hold various sized tools
- Belt clip slides onto belt for quick placement and removal
- Blue plastic



Item No.	Ref. No.	Dimensions	Finish	Pack
9925413103	-	9" L x 3.5" H x 1.75" W	Blue	1

Shopping Cart Sign Frame

- Weather-resistant sign frame mounts to shopping cart to display store messaging or advertising
- Unique design accommodates nearly any spacing in wire or molded cart openings
- Easy to install and change signage, no tools required
- Includes: (2) frame halves, (4) .5" screws, (2) .75" screws, (4) locking nuts and (2) cable ties for various mounting options
- Maximum space between frames .375"
- Holds 7" x 11" signs up to .08" thick
- Overall frame size is 11.5" W x 7.5" H
- Black shatter-resistant polypropylene

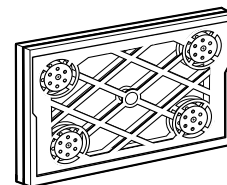

Item No.	Ref. No.	Dimensions	Finish	Pack
3700000000	-	11.5" W x 7.5" H	Black	1

Additional colors can be made to order (minimum quantities apply.)



Pop-Up Safety Cone

- Three-sided pop-up cone has safety message on all sides
- Bright yellow reflective fabric for maximum visibility
- English and Spanish on all three sides
- Folds to fit into included tube for easy storage
- Storage tube has holes for mounting to walls or doors (hardware not included)
- Yellow fabric

Item No.	Ref. No.	Dimensions	Finish	Pack
9926114968	-	31" H	Yellow	1

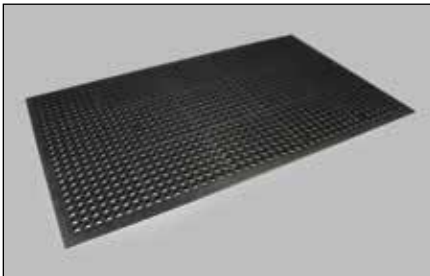

Drainage Mat

- High-traction surface and drainage holes make this mat ideal for wet floors in backrooms or behind counters
- Edge is beveled for easier access onto and off mat
- Black .5" thick oil-resistant rubber

Item No.	Ref. No.	Dimensions	Finish	Pack
9926419481	-	3' W x 5' L	Black	1

Broom/Mop Holder – Carlisle®

- Keep brooms, mops and brushes handy and secure
- Racks help prevent handle breakage, bristle damage, and damage to walls or counters
- Promotes fast drying of mops and wet broom bristles
- Rack is adjustable with unique plastic roller-grippers that self-adjust to different handle diameters with quick and easy release
- Mount with screws (provided) on 16” centers
- Black plastic



Item No.	Ref. No.	Dimensions	Finish	Pack
9926116462	-	18” L	Black	1

Additional sizes and styles can be made to order (minimum quantities apply.)

Dust Pan

- Long-handled dust pan reduces back fatigue
- Durable construction and easy handling
- Pan has sawtooth edge at the top of the opening for broom cleaning
- Pan is 10” W x 13” D; handle is 34” L



Item No.	Ref. No.	Dimensions	Finish	Pack
9926111032	-	10” W x 13” D x 34” H	Black	1

Additional sizes and styles can be made to order (minimum quantities apply.)

Ostrich Feather Duster

- Environmentally-friendly ostrich feathers, with no synthetic fibers
- Long-lasting duster can be washed repeatedly to extend service life
- Non-static style is safe to use on most surfaces and equipment
- Feathers retract into protective plastic cover for easy transfer
- Portable size is convenient
- 16” L, retracts to 10” L x 1.5” dia.
- Black handle / brown ostrich feathers



Item No.	Ref. No.	Dimensions	Finish	Pack
9926118011	-	16” L	Black / Brown	1

Additional sizes and styles can be made to order (minimum quantities apply.)

Cleaning Brushes

- Nylon brushes are the highest quality material stapled into premium quality, injection-molded polypropylene brush blocks
- High-heat brush has a stiff teflon 1.375” white bristle that will withstand temperatures up to 500°F, allowing equipment to be cleaned while still warm



Item No.	Ref. No.	Style	Dimensions	Pack
9926116336	-	Short Brush	8” L	1
9926110287	-	High-heat Brush	28” L	1

Additional sizes and styles can be made to order (minimum quantities apply.)



32-Gallon Container

- Engineered resin with seamless construction provides superior durability
- Molded handles for convenience and comfort
- Stackable with lid and nestable without lid
- 32 gallon capacity
- Gray plastic

Item No.	Ref. No.	Dimensions	Finish	Pack
9926310604	-	32 Gallon Container	Gray	1
9926314115	-	Lid	Gray	1

Additional sizes and styles are available.



Tall Slim Trash Receptacle and Swing Door Lid

- Slim-profile trash receptacle for smaller spaces
- Receptacle has 23 gallon capacity, receptacle measures 20" L x 11" W x 30" H; lid measures 20.25" L x 11.5" W x 4.5" H
- Swing-door lid for ease of use; lid sold separately
- Gray plastic

Item No.	Ref. No.	Dimensions	Finish	Pack
9926319193	-	Receptacle	Gray	1
9926314216	-	Lid	Gray	1

Additional sizes and colors are available.

5-Drawer Mobile Work Center

- Five convenient drawers allow for storage of your signage or supply needs
- Drawers measure: 22.25" L x 17" W x 2" D, 22.25" L x 17" W x 4" D, and 22.25" L x 17" W x 6" D
- Pegboard side panels provide additional organization space
- 4" diameter non-marking casters provide portability and are lockable for safety (2 locking, 2 swivel)
- Locking bar provides security and holds drawers in place
- Heavy-duty polypropylene



Item No.	Ref. No.	Style	Dimensions	Pack
9925111778	-	Five-drawer	32.5" L x 19.5" W x 33.5" H	1

Storage Cart with Tip-Out Bins

- Two-sided mobile storage cart can be used wherever extra storage space is needed
- 48 bins (24 each side) securely fit into cart, and will stay in place even during transport
- Excellent for storing cake decorations, balloons, supplies, and more
- Steel / gray polyethylene



Item No.	Ref. No.	Style	Dimensions	Pack
9925116567	-	48 Bins	26.5" L x 22" W x 58" H	1



Pan Rack

- All welded aluminum construction with heavy-duty runners and no nuts or bolts
- 20-pan capacity
- Aluminum rack is rust-proof and durable

Item No.	Ref. No.	Dimensions	Finish	Pack
9925118930	-	26" L x 20.5" W x 69" H	Silver	1

Additional sizes and styles can be made to order (minimum quantities apply.)



Platter Cart

- This versatile cart is ideal for meat, deli and produce departments
- Guaranteed against rust
- 12-runner cart holds 18" x 26" trays
- All-welded aluminum construction with no nuts or bolts

Item No.	Ref. No.	Dimensions	Finish	Pack
9925112508	-	27" L x 20" W x 69" H	Silver	1

Additional sizes and styles can be made to order (minimum quantities apply.)



Universal Cart

- Ideal transport/storage cart for all departments
- Narrow channel design efficiently handles a wide variety of containers, increasing storage and transport capabilities
- Rounded bar-style channels allow easy loading and unloading of product
- Holds trays, pans, lugs, and boxes up to 18" W x 26" L
- Available in 4-shelf or 8-shelf styles
- Aluminum

Item No.	Ref. No.	Style	Dimensions	Finish	Pack
9925114628	-	4-Shelf	27" L x 21" W x 43" H	Silver	1
9925116843	-	8-Shelf	27" L x 21" W x 67" H	Silver	1

Lug Cart

- Use to transport and store product in lugs
- All welded aluminum construction with large durable casters
- NSF Certified



Item No.	Ref. No.	Style	Dimensions	Pack
992511707	-	2-Runner Cart	16" L x 28" W x 34" H	1
9925112780	-	6-Runner Cart	16" L x 27" W x 71" H	1

Additional sizes and styles can be made to order (minimum quantities apply)

Plastic Lugs, Covers and Lug Dolly

- Excellent for produce or bulk meat handling
- Available with or without drainage holes
- Drain inserts available in two colors for organic and non-organic product
- Lugs nest for easy storage
- Made of high-impact polyethylene for lightness and durability
- Lug Dolly has four rolling casters; weight capacity of 500 lb; gray steel
- 9923616469 is NSF Certified



Item No.	Ref. No.	Style	Dimensions	Finish	Pack
9923610620	-	Lug	22" L x 15" W x 5" H	Gray	1
9923616469	-	Lug	26" L x 15" W x 8" H	Gray	1
9923619893	-	Lug	26" L x 18" W x 10" H	Gray	1
9923619894	-	Lug	26" L x 18" W x 10" H	Green	1
9923613050	-	Vented Lug	26" L x 18" W x 10" H	Gray	1
9923610621	-	Cover	22" L x 15" W	Gray	1
9923615382	-	Cover	26" L x 18" W	Gray	1
9923610604	-	Drain Insert	26" L x 18" W	Gray	1
9923610605	-	Drain Insert	26" L x 18" W	Green	1
9925113243	-	Lug Dolly	26" L x 18" W x 10" H	Gray	1

Additional sizes and colors can be made to order (minimum quantities apply)



Bulk Mover

- Cart is durably constructed with an all-welded aluminum frame
- White plastic tub is removable and easy to clean
- 5" dia x 1.5" H wheels are standard polyurethane with swivel stem casters
- Silver aluminum / white plastic
- NSF Certified



Item No.	Ref. No.	Dimensions	Finish	Pack
9925116562	-	22" L x 36" W x 36" H	Silver / White	1

Sheet Pan Dolly

- Use this rack to move and store bakery sheet pans
- Aluminum construction prevents rust

Item No.	Ref. No.	Dimensions	Finish	Pack
9925518863	-	27" L x 21" W x 32" H	Silver	1





Three Shelf Economy Cart

- Handy gray three-tier design, featuring attractive yet rugged brushed-aluminum uprights
- Super quiet, non-marking 4" casters and plastic construction reduce noise

Item No.	Ref. No.	Dimensions	Finish	Pack
9925115463	-	31" L x 16" W x 37" H	Gray	1
9925114364	-	40" L x 20" W x 38" H	Gray	1



Two Shelf Stock Cart

- Large 5" sealed wheels assure smooth handling under all conditions
- Heavy-capacity, all-welded steel tube construction

Item No.	Ref. No.	Dimensions	Finish	Pack
9925110164	-	44" L x 18" W x 38" H	Silver	1



Two Shelf Utility Cart

- Sturdy cart has 400 lb capacity; 200 lb capacity per shelf
- Raised lip sides keep product secure on cart
- Non-marking 5" casters assure easy transport
- Sturdy structural foam construction won't rust, dent, chip or peel

Item No.	Ref. No.	Dimensions	Finish	Pack
9925111384	-	40.375" L x 25.5" W x 33" H	Gray	1



Raised Handle Utility Cart

- Sturdy cart has 500 lb capacity; 250 lb per shelf
- Ergonomic handle is at optimal height for improved control and worker safety
- Molded-in storage compartments
- Non-marking 5" casters
- Black plastic

Item No.	Ref. No.	Dimensions	Finish	Pack
9925117710	-	39" L x 17.875" W x 33.25" H	Black	1

The Next Generation in Fresh Area Solutions



Phone **800.422.2547**
Fax **800.422.2502**
Web **www.siffron.com**

call toll-free in North America
fax us your purchase order
find and buy resources online

The Siffron logo features the word "siffron" in a bold, blue, sans-serif font. A small green diamond is positioned above the letter 'i'. A registered trademark symbol (®) is located at the end of the word. The logo is set against a white rectangular background.

siffron®

See more great solutions
on our website!

www.siffron.com
800.422.2547